

SENSAPHONE®

DESKTOP MONITORING SYSTEM

Model 400

User's Manual



Spectrum®
Technologies, Inc.

12360 S. Industrial Dr. E
Plainfield IL 60585
(800) 248-8873 or (815) 436-4440
Fax (815) 436-4460
E-Mail: info@specmeters.com
www.specmeters.com

SENSAPHONE®

Model 400

User's Manual

Version 1.2.1

IMPORTANT SAFETY INSTRUCTIONS

Your Model 400 has been carefully designed to give you years of safe, reliable performance. As with all electrical equipment, however, there are a few basic precautions you should take to avoid hurting yourself or damaging the unit:

- Read the installation and operating instructions in this manual carefully. Be sure to save it for future reference.
- Read and follow all warning and instruction labels on the product itself.
- To protect the Model 400 from overheating, make sure all openings on the unit are not blocked. Do not place on or near a heat source, such as a radiator or heat register.
- Do not use your Model 400 near water, or spill liquid of any kind into it.
- Be certain that your power source matches the rating listed on the AC power transformer. If you're not sure of the type of power supply to your facility, consult your dealer or local power company.
- Do not allow anything to rest on the power cord. Do not locate this product where the cord will be abused by persons walking on it.
- Do not overload wall outlets and extension cords, as this can result in the risk of fire or electric shock.
- Never push objects of any kind into this product through ventilation holes as they may touch dangerous voltage points or short out parts that could result in a risk of fire or electric shock.
- To reduce the risk of electric shock, do not disassemble this product, but return it to Sensaphone Customer Service, or other approved repair facility, when any service or repair work is required. Opening or removing covers may expose you to dangerous voltages or other risks. Incorrect reassembly can cause electric shock when the unit is subsequently used.
- If anything happens that indicates that your Model 400 is not working properly or has been damaged, unplug it immediately and follow the procedures in Appendix F for having it serviced. Return the unit for servicing under the following conditions:

1. The power cord or plug is frayed or damaged.
 2. Liquid has been spilled into the product or it has been exposed to water.
 3. The unit has been dropped, or the cabinet is damaged.
 4. The unit doesn't function normally when you're following the operating instructions.
- Avoid using a telephone (other than a cordless type) during an electrical storm. There may be a remote risk of electric shock from lightning.
 - Do not use the telephone to report a gas leak in the vicinity of the leak.

CAUTION

To Reduce the Risk of Fire or Injury to Persons, Read and Follow these Instructions:

1. Use only the following type and size batteries:
Alkaline, size C.
2. Do not dispose of the batteries in a fire. The cell may explode. Check with local codes for possible special disposal instructions.
3. Do not open or mutilate the batteries. Released electrolyte is corrosive and may cause damage to the eyes or skin. It may be toxic if swallowed.
4. Exercise care in handling batteries in order not to short the battery with conducting materials such as rings, bracelets, and keys. The battery or conductor may overheat and cause burns.
5. Do not mix old and new batteries in this product.

FCC Requirements

Part 68: The Sensaphone® Model 400 complies with Part 68 of the FCC rules. On the back of the unit there is a label that contains, among other information, the FCC Registration Number and the Ringer Equivalence Number (REN) for this equipment. You must, upon request, provide this information to your local telephone company.

The REN is useful to determine the quantity of devices that you may connect to your telephone line and still have all of those devices ring when your telephone number is called. In most, but not all areas, the sum of the RENs of all devices connected to one line should not exceed five (5.0). To be certain of the number of devices that you may connect to your line, you may want to contact your local telephone company to determine the maximum REN for your calling area.

This equipment may not be used on coin service provided by the telephone company. Connection to party lines is subject to state tariffs.

Should the Model 400 cause harm to the telephone network, the telephone company may discontinue your service temporarily. If possible, they will notify you in advance. But if advance notice isn't practical, the telephone company may temporarily discontinue service without notice and you will be notified as soon as possible. You will be informed of your right to file a complaint with the FCC. The telephone company may make changes in its facilities, equipment, operations, or procedures where such action is reasonably required in the operation of its business and is not inconsistent with the rules and regulations of the FCC that could affect the proper functioning of your equipment. If they do, you will be notified in advance to give you an opportunity to maintain uninterrupted telephone service.

If you experience trouble with this equipment, or you need information on obtaining service or repairs, please contact:

The telephone company may ask that you disconnect this equipment from the network until the problem has been corrected or until you are sure that the equipment is not malfunctioning.

Part 15: This equipment has been tested and found to comply with the limits for a Class B digital device, pursuant to Part 15 of the FCC Rules. These limits are designed to provide reasonable protection against harmful interference in a residential installation. This equipment generates, uses and can radiate radio frequency energy and, if not installed and used in accordance with the instructions, may cause harmful interference to radio communications. However, there is no guarantee that interference will not occur in a particular installation. If this equipment does cause harmful interference to radio or television reception, which can be determined by turning the equipment off and on, the user is encouraged to try to correct the interference by one or more of the following measures:

- Reorient or relocate the receiving antenna.
- Increase the separation between the equipment and the receiver.
- Connect the equipment into an outlet on a circuit different from that to which the receiver is connected.
- Consult the dealer or an experienced radio/television technician for help.

Canadian Department of Communications Statement

Notice: The Canadian Department of Communications label identifies certified equipment. This certification means that the equipment meets certain telecommunications network protective operational and safety requirements. The Department does not guarantee the equipment will operate to the user's satisfaction.

Before installing this equipment, users should ensure that it is permissible to be connected to the facilities of the local telecommunications company. The equipment must also be installed using an acceptable method of connection. In some cases, where the company's inside wiring is associated with a single line, individual service may be extended by means of a certified connector assembly (telephone extension cord). The customer should be aware that compliance with the above conditions may not prevent degradation of service in some situations.

Repairs to certified equipment should be made by an authorized Canadian maintenance facility designated by the supplier. Any repairs or alterations made by the user to this equipment, or equipment malfunctions, may give the telecommunications company cause to request the user to disconnect the equipment.

Users should ensure for their own protection that the electrical ground connections of the power utility telephone lines and internal metallic water pipe system, if present, are connected together. This precaution may be particularly important in rural areas.

CAUTION: Users should not attempt to make such connections themselves, but should contact the appropriate electric inspection authority, or electrician, as appropriate.

The Load Number (LN) assigned to each terminal device denotes the percentage of the total load to be connected to a telephone loop which is used by the device to prevent overloading. The termination on loop may consist of any combination of devices subject only to the requirement that the total of the Load Numbers of all the devices does not exceed 100. For the Sensaphone® Model 400, the Load Number is 0.3.

1 YEAR LIMITED WARRANTY

PLEASE READ THIS WARRANTY CAREFULLY BEFORE USING THE PRODUCT.

THIS LIMITED WARRANTY CONTAINS SENSAPHONE'S STANDARD TERMS AND CONDITIONS. WHERE PERMITTED BY THE APPLICABLE LAW, BY KEEPING YOUR SENSAPHONE PRODUCT BEYOND THIRTY (30) DAYS AFTER THE DATE OF DELIVERY, YOU FULLY ACCEPT THE TERMS AND CONDITIONS SET FORTH IN THIS LIMITED WARRANTY.

IN ADDITION, WHERE PERMITTED BY THE APPLICABLE LAW, YOUR INSTALLATION AND/OR USE OF THE PRODUCT CONSTITUTES FULL ACCEPTANCE OF THE TERMS AND CONDITIONS OF THIS LIMITED WARRANTY (HEREINAFTER REFERRED TO AS "LIMITED WARRANTY OR WARRANTY"). IF YOU DO NOT AGREE TO THE TERMS AND CONDITIONS THIS WARRANTY, INCLUDING ANY LIMITATIONS OF WARRANTY, INDEMNIFICATION TERMS OR LIMITATION OF LIABILITY, THEN YOU SHOULD NOT USE THE PRODUCT AND SHOULD RETURN IT TO THE SELLER FOR A REFUND OF THE PURCHASE PRICE. THE LAW MAY VARY BY JURISDICTION AS TO THE APPLICABILITY OF YOUR INSTALLATION OR USE ACTUALLY CONSTITUTING ACCEPTANCE OF THE TERMS AND CONDITIONS HEREIN AND AS TO THE APPLICABILITY OF ANY LIMITATION OF WARRANTY, INDEMNIFICATION TERMS OR LIMITATIONS OF LIABILITY.

1. **WARRANTOR:** In this Warranty, Warrantor shall mean "Dealer, Distributor, and/or Manufacturer."
2. **ELEMENTS OF WARRANTY:** This Product is warranted to be free from defects in materials and craftsmanship with only the limitations and exclusions set out below.
3. **WARRANTY AND REMEDY:** One-Year Warranty — In the event that the Product does not conform to this warranty at any time during the time of one year from original purchase, warrantor will repair the defect and return it to you at no charge.

This warranty shall terminate and be of no further effect at the time the product is: (1) damaged by extraneous cause such as fire, water, lightning, etc. or not maintained as reasonable and necessary; or (2) modified; or (3) improperly installed; or (4) misused; or (5) repaired or serviced by someone other than Warrantors' authorized personnel or someone expressly authorized by Warrantor's to make such service or repairs; (6) used in a manner or purpose for which the product was not intended; or (7) sold by original purchaser.

LIMITED WARRANTY, LIMITATION OF DAMAGES AND DISCLAIMER OF LIABILITY FOR DAMAGES: THE WARRANTOR'S OBLIGATION UNDER THIS WARRANTY IS LIMITED TO REPAIR OR REPLACEMENT OF THE PRODUCT, AT THE WARRANTOR'S OPTION AS TO REPAIR OR REPLACEMENT. IN NO EVENT SHALL WARRANTORS BE LIABLE OR RESPONSIBLE FOR PAYMENT OF ANY INCIDENTAL, CONSEQUENTIAL, SPECIAL AND/OR PUNITIVE DAMAGES OF ANY KIND, INCLUDING BUT NOT LIMITED TO ANY LABOR COSTS, PRODUCT COSTS, LOST REVENUE, BUSINESS INTERRUPTION LOSSES, LOST PROFITS, LOSS OF BUSINESS, LOSS OF DATA OR INFORMATION, OR FINANCIAL LOSS, FOR CLAIMS OF ANY NATURE, INCLUDING BUT NOT LIMITED TO CLAIMS IN CONTRACT, BREACH OF WARRANTY OR TORT, AND WHETHER OR NOT CAUSED BY WARRANTORS' NEGLIGENCE. IN THE EVENT THAT IT IS DETERMINED IN ANY ADJUDICATION THAT THE LIMITED WARRANTIES OF REPAIR OR REPLACEMENT ARE INAPPLICABLE, THEN THE PURCHASER'S SOLE REMEDY SHALL BE PAYMENT TO THE PURCHASER OF THE ORIGINAL COST OF THE PRODUCT, AND IN NO EVENT SHALL WARRANTORS BE LIABLE OR RESPONSIBLE FOR PAYMENT OF ANY INCIDENTAL, CONSEQUENTIAL, SPECIAL AND/OR PUNITIVE DAMAGES OF ANY KIND, INCLUDING BUT NOT LIMITED TO ANY LOST REVENUE, BUSINESS INTERRUPTION LOSSES, LOST PROFITS, LOSS OF BUSINESS, LOSS OF DATA OR INFORMATION, OR FINANCIAL LOSS, FOR CLAIMS OF ANY NATURE, INCLUDING BUT NOT LIMITED TO CLAIMS IN CONTRACT, BREACH OF WARRANTY OR TORT, AND WHETHER OR NOT CAUSED BY WARRANTORS' NEGLIGENCE.

WITHOUT WAIVING ANY PROVISION IN THIS LIMITED WARRANTY, IF A CIRCUMSTANCE ARISES WHERE WARRANTORS ARE FOUND TO BE LIABLE FOR ANY LOSS OR DAMAGE ARISING OUT OF MISTAKES, NEGLIGENCE, OMISSIONS, INTERRUPTIONS, DELAYS, ERRORS OR DEFECTS IN WARRANTORS' PRODUCTS OR SERVICES, SUCH LIABILITY SHALL NOT EXCEED THE TOTAL AMOUNT PAID BY THE CUSTOMER FOR WARRANTORS' PRODUCT AND SERVICES OR \$250.00, WHICHEVER IS GREATER. YOU HEREBY RELEASE WARRANTORS FROM ANY AND ALL OBLIGATIONS, LIABILITIES AND CLAIMS IN EXCESS OF THIS LIMITATION.

INDEMNIFICATION AND COVENANT NOT TO SUE: YOU WILL INDEMNIFY, DEFEND AND HOLD HARMLESS WARRANTORS, THEIR OWNERS, DIRECTORS, OFFICERS, EMPLOYEES, AGENTS, SUPPLIERS OR AFFILIATED COMPANIES, AGAINST ANY AND ALL CLAIMS, DEMANDS OR ACTIONS BASED UPON ANY LOSSES, LIABILITIES, DAMAGES OR COSTS, INCLUDING BUT NOT LIMITED TO DAMAGES THAT ARE DIRECT OR INDIRECT, INCIDENTAL, SPECIAL OR CONSEQUENTIAL, AND INCLUDING ATTORNEYS FEES AND LEGAL COSTS, THAT MAY RESULT FROM THE INSTALLATION, OPERATION, USE OF, OR INABILITY TO USE WARRANTORS' PRODUCTS AND SERVICES, OR FROM THE FAILURE

OF THE WARRANTORS' SYSTEM TO REPORT A GIVEN EVENT OR CONDITION, WHETHER OR NOT CAUSED BY WARRANTORS' NEGLIGENCE.

YOU AGREE TO RELEASE, WAIVE, DISCHARGE AND COVENANT NOT TO SUE WARRANTORS, THEIR OWNERS, DIRECTORS, OFFICERS, EMPLOYEES, AGENTS, SUPPLIERS OR AFFILIATED COMPANIES, FOR ANY AND ALL LIABILITIES POTENTIALLY ARISING FROM ANY CLAIM, DEMAND OR ACTION BASED UPON ANY LOSSES, LIABILITIES, DAMAGES OR COSTS, INCLUDING BUT NOT LIMITED TO DAMAGES THAT ARE DIRECT OR INDIRECT, INCIDENTAL, SPECIAL OR CONSEQUENTIAL, AND INCLUDING ATTORNEYS FEES AND LEGAL COSTS, THAT MAY RESULT FROM THE INSTALLATION, OPERATION, USE OF, OR INABILITY TO USE WARRANTORS' PRODUCTS AND SERVICES, OR FROM THE FAILURE OF THE WARRANTORS' SYSTEM TO REPORT A GIVEN EVENT OR CONDITION, WHETHER OR NOT CAUSED BY WARRANTORS' NEGLIGENCE, EXCEPT AS NECESSARY TO ENFORCE THE EXPRESS TERMS OF THIS LIMITED WARRANTY.

EXCLUSIVE WARRANTY: THE LIMITED WARRANTY OR WARRANTIES DESCRIBED HEREIN CONSTITUTE THE SOLE WARRANTY OR WARRANTIES TO THE PURCHASER. ALL IMPLIED WARRANTIES ARE EXPRESSLY DISCLAIMED, INCLUDING: THE WARRANTY OF MERCHANTABILITY AND THE WARRANTY OF FITNESS FOR A PARTICULAR USE AND THE WARRANTY OF FITNESS FOR A PARTICULAR PURPOSE AND THE WARRANTY OF NON-INFRINGEMENT AND/OR ANY WARRANTY ARISING FROM A COURSE OF DEALING, USAGE, OR TRADE PRACTICE.

It must be clear that the Warrantors are not insuring your premises or business or guaranteeing that there will not be damage to your person or property or business if you use this Product. You should maintain insurance coverage sufficient to provide compensation for any loss, damage, or expense that may arise in connection with the use of products or services, even if caused by Warrantors' negligence. The warrantors assume no liability for installation of the Product and/or interruptions of the service due to strikes, riots, floods, fire, and/or any cause beyond Seller's control, further subject to the limitations expressed in any License Agreement or other Agreement provided by Warrantors to purchaser.

The agreement between the Warrantors and the Purchaser, including but not limited to the terms and conditions herein shall not be governed by the Convention for the International Sale of Goods. Where applicable, the Uniform Commercial Code as adopted by the State of Delaware shall apply.

4. PROCEDURE FOR OBTAINING PERFORMANCE OF WARRANTY: In the event that the Product does not conform to this warranty, the Product should be shipped or delivered freight prepaid to a Warrantor with evidence of original purchase.

5. LEGAL REMEDIES AND DISCLAIMER: Some jurisdictions may not allow, or may place limits upon, the exclusion and/or limitation of implied warranties, incidental damages and/or consequential damages for some types of goods or products sold to consumers and/or the use of indemnification terms. Thus, the exclusions, indemnification terms and limitations set out above may not apply, or may be limited in their application, to you. If the implied warranties can not be excluded, and the applicable law permits limiting the duration of implied warranties, then the implied warranties herein are to be limited to the same duration as the applicable written warranty or warranties herein. The warranty or warranties herein may give you specific legal rights that will depend upon the applicable law. You may also have other legal rights depending upon the law in your jurisdiction.

6. CHOICE OF FORUM AND CHOICE OF LAW: In the event that a dispute arises out of or in connection with this Limited Warranty, then any claims or suits of any kind concerning such disputes shall only and exclusively be brought in either the Court of Common Pleas of Delaware County, Pennsylvania or the United States District Court for the Eastern District of Pennsylvania.

Regardless of the place of contracting or performance, this Limited Warranty and all questions relating to its validity, interpretation, performance and enforcement shall be governed by and construed in accordance with the laws of the State of Delaware, without regard to the principles of conflicts of law.

TABLE OF CONTENTS

IMPORTANT SAFETY INSTRUCTIONS	iii
FCC Requirements	v
Canadian Department of Communications Statement	vii
1 YEAR LIMITED WARRANTY	viii

Chapter 1: Introduction18

Layout	20
1. Programming Keypad	20
2. Power Jack	20
3. Phone Extension Jack	20
4. Phone Line Jack	20
5. Speaker	20
6. Built in Microphone	20
7. System on LED	20
8. Phone-in-use LED	20
9. Alarm LED	20
10. Battery ok LED	20
11. Battery Compartment	20
12. Input/Output Wiring Door	20
LED INDICATORS	20
Technical Support	21

Chapter 2: Installation22

2.1 Operating Environment	22
2.2 Mounting	22
2.3 Power Surge Protection	23
2.4 Power Supply and Battery Backup	23
2.5 Starting the Model 400	24
2.6 Run Mode and Standby Mode	24
2.7 Telephone Line	25
2.8 The Microphone	26
2.9 Alert Zones	27
2.10 Installing the Sensor	28
2.11 Multiple Sensors	29

2.12 Outdoor Wiring	30
2.13 Disconnecting the Model 400 for Storage or Seasonal Use.	31
Chapter 3: Quick Start	32
3.1 The Local Keypad	32
3.2 Preparation for Programming	32
3.3 Quick-Start Programming Steps	33
Step 1: Set Configuration of Zones	33
Step 2: Set the ID Number.	34
Step 3: Set Dial-Out Telephone Numbers	34
Step 4: Set Temperature Limits	35
3.4 Summary of the Alarm Dial-Out Process	38
Chapter 4: Communications Programming	40
4.1 Voice Messages	40
4.2 The Unit ID Number	43
4.2.1 Programming the ID Number	44
4.2.2 Interrogating the ID Number	44
4.3 Dial-out Telephone Numbers.	45
4.3.1 Programming Dial-out Telephone Numbers.	45
4.3.2 Interrogating a Dial-out Telephone Number	46
4.3.3 Erasing a Telephone Number	46
4.4 Tone or Pulse Dialing	47
4.5 Special Dialing.	47
4.5.1 Special Dialing Keys.	48
4.5.2 Incorporating a Pause	50
4.5.3 Incorporating a Pound (#) or Star (*)	51
4.5.4 Special Dialing to a Beeper or Pager	52
4.6 Rings Until Answer	53
4.6.1 Programming Rings Until Answer	53
4.6.2 Interrogating Rings Until Answer.	54
4.7 TAD (Telephone Answering Device)	54
4.7.1 TAD Enable/Disable	54
4.7.2 Using the TAD Feature	55
4.7.3 No TAD In Use	56
4.8 Listen-in Time	56
4.8.1 Programming the Listen-in Time	56

4.8.2 Interrogating the Listen-in Time	57
4.9 Call Delay	57
4.9.1 Programming the Call Delay	57
4.9.2 Interrogating Call Delay	58
4.10 Local Voice Mute	58
4.10.1 Enable/Disable Local Voice Mute	59
4.11 Voice Repetitions.	59
4.11.1 Programming Voice Repetitions.	59
4.11.2 Interrogating Voice Repetitions	60
4.12 Intercall Time.	60
4.12.1 Programming Intercall Time.	61
4.12.2 Interrogating Intercall Time	62
4.13 Maximum Number of Calls (Max Calls).	62
4.13.1 Programming Max Calls.	63
4.13.2 Interrogating Max Calls	63
4.14 The Clock.	64
4.14.1 Setting the Clock.	64
4.14.2 Interrogating for the Current Time	65
4.15 The Security Code	65
4.15.1 Locking the Keypad	65
4.15.2 Unlocking the Keypad	66

Chapter 5: Alarm Programming68

5.1 Zone Configuration.	68
5.1.1 Programming Zone Configuration	69
5.1.2 Interrogating Zone Configuration.	70
5.2 Enable/Disable Zones	70
5.2.1 Changing Enabled/Disabled Zone Status	70
5.2.2 Verifying Enabled/Disabled Zone Status	71
5.3 Zone Recognition Time	71
5.3.1 Programming Zone Recognition Time	72
5.3.2 Interrogating Zone Recognition Time	73
5.4 Establishing High and Low Temperature Limits	74
5.4.1 Programming Temperature Limits for a Selected Zone	74
5.4.2 Disabling Alarm Response to High or Low Temperature .75	
5.4.3 Interrogating High and Low Temperature Limits	76
5.5 Temperature Scale	76

5.6	Temperature Calibration	77
5.6.1	Programming Temperature Calibration	77
5.6.2	Interrogating Temperature Calibration	78
5.7	Obtaining Current Temperature	78
5.8	AC Power Monitoring Enable/Disable	79
5.8.1	Enabling/Disabling the AC Power Alarm	79
5.9	AC Power Failure Recognition Time	79
5.9.1	Programming Power Failure Recognition Time	80
5.9.2	Interrogating Power Failure Recognition Time	81
5.10	Sound Alarm Monitoring	81
5.10.1	Programming Sound Alarm Sensitivity	81
5.10.2	Interrogating Sound Sensitivity	82
5.10.3	Programming High Sound Alarm Recognition Time	82
5.10.4	Interrogating High Sound Alarm Recognition Time	83
5.11	High Sound Alarm Enable/Disable	83
5.11.1	Changing Enabled/Disabled High Sound Alarm	84
5.12	Exit Delay	84
5.13	Designating A Zone Unused	85

Chapter 6: Acknowledgment, Status Report & Remote Access 86

6.1	Alarm Acknowledgment	86
6.1.1	Local Acknowledgment	86
6.1.2	Touch-Tone™ Acknowledgment	86
6.1.3	Callback Acknowledgment	87
6.2	Status Report	88
6.2.1	Example: Status Report, No Alarms	89
6.2.2	Example: Status Report, Existing Alarms	90
6.2.3	Example: Status Report, Disabled Zones	90
6.2.4	Battery Condition	91
6.2.5	Remote Access by Touch-Tone™ Telephone	91

Chapter 7: Operation	96
7.1 Alarm Detection, Dial-out and Acknowledgment.....	96
7.2 Example: A Dial-out Telephone Call	101
Chapter 8: Controlling the Output	102
8.1 Output Modes	102
8.1.1 To Program the Output Mode	103
8.1.2 To play back the programmed Output Mode	104
8.2 Switching The Output Using The Keypad	104
8.3 Typical Applications	105
8.3.1 Single Thermostat Control	105
8.3.2 Dual Thermostat Control	108
8.3.3 Controlling Lights Or Other Devices.....	110
Appendix A: Weekly Testing Procedure	112
Appendix B: Troubleshooting	114
Appendix C: 400 QUICK REFERENCE	124
Appendix D: Accessories	128
Appendix E: Specifications	130
Appendix F: Returning the Unit for Repair	132
Appendix G: Test Log	134

Chapter 1: Introduction

The Sensaphone® Model 400 is a fully-programmable, environmental monitoring system that offers extensive on-site and remote monitoring capability to small businesses, private homes, farms, greenhouses, computer rooms, and remote facilities. Designed for desktop or wall mounting, the Model 400 is simple to install, program and operate; no changes to standard electrical or telephone service are required. When connected to a telephone line, it will respond to an alarm by dialing up to four separate telephone numbers. When the call is answered, an “Alert Condition” message is delivered in user recordable voice.

The Model 400 features built-in sensors to monitor a variety of conditions:

- High sound level
- AC electric power failure
- Battery backup
- Temperature*

*Note: While technically not a “built-in” sensor, temperature is factory installed on zone 1.

The 400 is equipped with 4 alert zones. Additional sensors* can be added to extend monitoring capabilities to include:

- Intrusion or unauthorized entry
- Water leaks and seepage
- Temperature
- Humidity
- Equipment operation
- Many other conditions that may require unique monitoring solutions

* Refer to Appendix D for information on additional sensors (available separately from Sensaphone) best suited to your application.

The status of each monitored condition is readily obtained at the unit’s installation site, or remotely by telephone. At the close of every Status Report, time is provided for listening to on-site sounds.

To ensure reliable operation, the Model 400 features power backup capability; in the event of AC power failure, six C-cell

alkaline batteries (not included) will continue to power the unit for approximately 24 hours.

Feature Summary

The Sensaphone 400 includes the following features:

- Four zones configurable as temperature or dry contact
- Each zone can be individually enabled or disabled
- Fully automatic input configuration
- Temperature sensor included on zone #1
- Calibration for each zone
- Power monitor
- High sound-level monitor
- User-recordable voice messages
- Dial out to four telephone numbers
- Alarm dial out via voice and numeric pager
- Microphone for onsite listen-in
- Built-in line seizure
- Relay output (manual or automatic control)
- Four status LEDs
- Surge protection on all zones, telephone line, and power supply
- 24 hour battery backup (batteries not included)
- Wall or desktop installation

About This Manual

This manual comprises the instructions and commands for installing and operating the Model 400. The Quick Start chapter is included to speed understanding of programming and operation. Communication and Alarm Programming chapters demonstrate step-by-step methods for utilizing the full range of available features. The Troubleshooting chapter provides assistance in the event that problems are encountered.

Layout

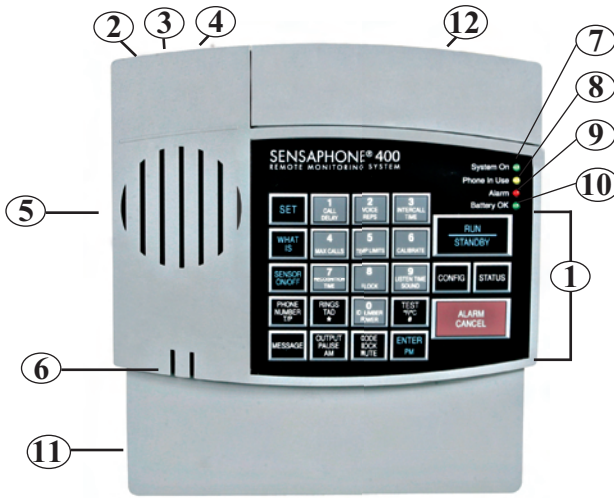

1. Programming Keypad
2. Power Jack
3. Phone Extension Jack
4. Phone Line Jack
5. Speaker
6. Built in Microphone
7. System on LED
8. Phone-in-use LED
9. Alarm LED
10. Battery OK LED
11. Battery Compartment
12. Input/Output Wiring Door

LED INDICATORS

The LEDs provide on-site alarm and status information. Listed below are descriptions of how the LEDs work.

System On

LED Off: Unit is off

LED On: Unit is in Run mode

LED Blinking: Unit is in Standby mode

Phone-In-Use

LED On: The unit or some other device is communicating on the phone line

LED Off: Phone line is not in use

LED Blinking: No telephone service detected

Alarm

LED Off: No alarms exist

LED Blinking: Unacknowledged alarm exists

LED On: Acknowledged alarm exists

Battery OK

LED On: Battery condition good

LED Blinking: Battery condition low

LED Off: No battery/critically low battery condition

Technical Support

If any questions arise upon installation or operation of the Model 400, please contact the Sensaphone Technical Service Department at the number shown below, and have the following information:

- Date of Purchase _____
- Serial number of your Model 400 _____

Technical Support is available from 8:00AM to 5:00PM

Chapter 2: Installation

Correctly installing the Model 400 will ensure proper functioning of the unit. Please read the entire chapter before starting the installation process.

Within the packaging will be a Warranty Registration Card. Please take the time to fill this out and mail. The One Year Limited Warranty is explained in the front of this manual.

2.1 Operating Environment

The Model 400 should be installed and operated in a clean, dry area that provides space for wiring sensors to the screw terminals, near an AC power source and telephone line. Operating temperature ranges from 32° Fahrenheit (0° Celsius) to +122° Fahrenheit (+50° Celsius).

NOTE

The Model 400 is a sensitive electronic device. **Do not** install the Model 400 near strong electrostatic, electromagnetic or radioactive fields. **Do not** expose to humid environments, fumes, or corrosive vapors.

2.2 Mounting

Flat Mount: Place the Model 400 on top of a desk or other horizontal surface. Wall Mount: Mount on a wall with two flathead screws using the keyholes on the back panel of the unit. Place the flathead screws or bolts 4” apart at the desired height from the floor. Hook the unit over the screws and toward the floor. Refer to Figure 2-1.

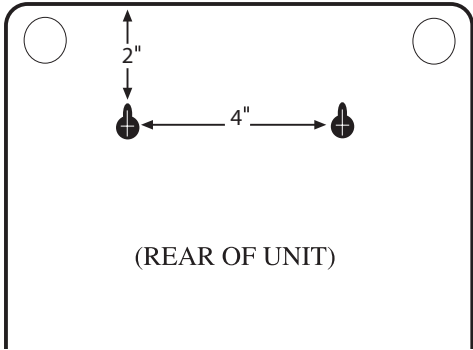

Figure 2-1. Wall Mount

2.3 Power Surge Protection

The Model 400 can be damaged by power surges and lightning through the telephone line and the 120 VAC power supply. Although the Model 400 has built-in surge protection, we recommend that additional protection be obtained for the unit and for any electronic equipment that is attached to your power supply and telephone lines. Power surge protection is especially important if you live in a lightning-prone area. The ISOTEL Surge Protector Model IB-4 is available through Sensaphone. See Appendix D.

2.4 Power Supply and Battery Backup

The Model 400 is provided with a DC power transformer that will plug into any standard 120 VAC outlet and a battery backup (batteries not included) that enables the unit to continue functioning if AC power is removed (due to electric power disruption or failure). The Model 400 uses six, C-cell alkaline batteries. Do not use rechargeable batteries. Connect the DC power transformer into the jack on the back of the unit and plug the adaptor into a 120VAC outlet

NOTE

Be sure that the DC transformer is plugged into an outlet before installing batteries.

To install the batteries, remove the battery compartment door located on the front of the unit below the keypad. Press down and slide the door away from the unit, align batteries according to the diagram shown in Figure 2-2, and replace the hatch.

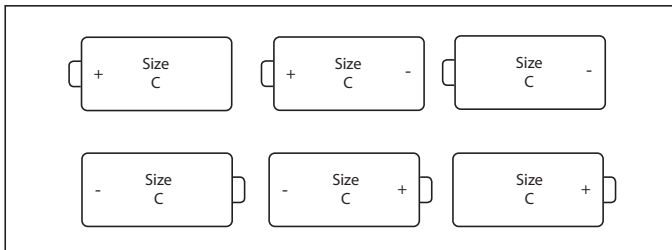

Figure 2-2. Battery Installation

2.5 Starting the Model 400

When the DC power transformer is first plugged into the electrical outlet, the Model 400 automatically starts in RUN mode. The *System On* light will begin to glow. The unit will respond with, “Hello, this is Sensaphone 400.”

2.6 Run Mode and Standby Mode

Pressing the RUN/STANDBY key on the Model 400 keypad will alternately activate or deactivate the unit. If the unit is activated and in RUN mode, the system on light glows steadily. In STANDBY mode, the system on light goes out, but will blink every few seconds to indicate that power is still supplied to the unit.

In RUN mode, the Model 400 is able to receive incoming calls and to dial out automatically in the event of an alarm on one of the monitored conditions. To enter STANDBY mode, press RUN/STANDBY.

As soon as the Model 400 enters STANDBY mode, it responds with “Goodbye.” The system on light immediately goes out and then resumes with a blink every few seconds. While in STANDBY mode, all functions are disabled, but programmed memory is preserved. Upon exiting STANDBY mode, any currently existing alarms will be announced.

NOTE

STANDBY mode is not equivalent to “power off”—an electrical source, such as the 120 VAC, or the battery backup, continues to provide full power to the unit. If the unit is placed in STANDBY mode, unplugged from the 120 VAC outlet, and placed in storage, the batteries will continue to power the Model 400, discharging until they fail. Consequently, batteries should always be removed from the unit following disconnection from any 120 VAC outlet, prior to storage.

Press the RUN/STANDBY key again to return to RUN mode.



Figure 2-3. The RUN/STANDBY Key

2.7 Telephone Line

The Model 400 will operate with all standard analog telephone lines that accept pulse or tone dialing. The Model 400 cannot be used on an extension line to dial its own telephone number. Also, it may **not** be installed on a party line, pay telephone line, or digital telephone system.

Certain private telephone systems and public switching equipment may not accept the Model 400 dialing or may generate an unacceptable ring signal. In those cases, a dedicated line may be required. Consult the supplier of your telephone system if you encounter problems.

If you do not have a modular telephone extension at the Model 400's location, you must contact your local telephone company to have one installed (there is a charge for this service). If you have four-pin jacks, adapters are available to convert them to the modular plugs. Contact your local telephone company or electronics parts store.

CAUTION

Never install telephone wiring during a lightning storm. Never install telephone jacks in wet locations unless the jack is specifically designed for wet locations. Never touch uninsulated telephone wires or terminals unless the telephone line has been disconnected at the network interface. Use caution when installing or modifying telephone lines.

To install the telephone line, plug one end of the modular cord into the "line" jack on the back of the model 400 (as shown) and plug the other end into any standard RJ11 phone outlet. Refer to Figure 2-4.

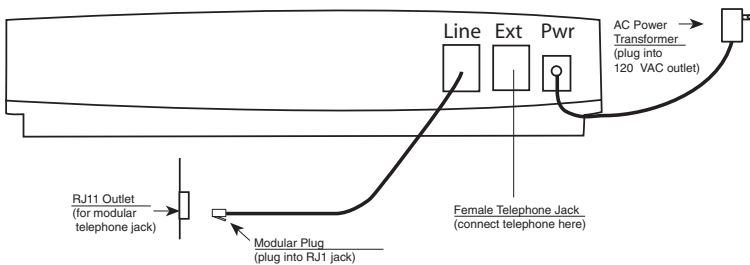

Figure 2-4. Installing the Telephone Line

On the back of the Model 400 is an extra female telephone jack labeled "EXT". This is provided so that a telephone or other answering device may be used on the same line as the unit.

(It is not necessary to hook up a telephone for the Model 400 to operate.) This extension jack features Line Seizure which means that it will disconnect the extension jack when the Model 400 needs to make a telephone call. To ensure that the unit has priority over any other device on the line, you must connect all extensions to this jack. (see figure)

On the unit there are two RJ11C phone jacks:

- The RJ11C jack labeled “LINE” is to be connected to the incoming line of your phone service, ahead of all other phones or telephone extensions.
- The RJ11C telephone jack labeled “EXT” is to be connected to all extensions.

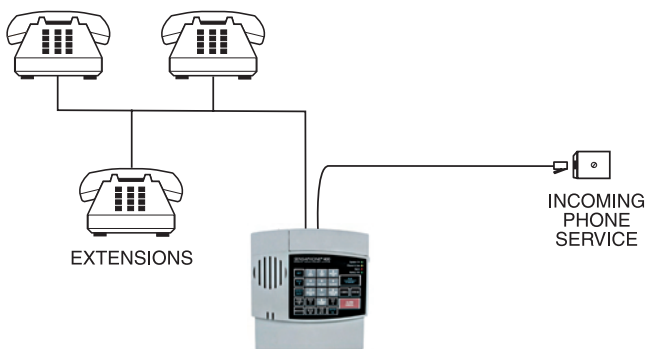

2.8 The Microphone

The Model 400 is provided with a built-in microphone which is used to monitor high sound levels produced near the installation site. The sensitivity of the microphone is configurable and will detect a continuous as well as a pulsating alarm. Note that beeping alarms that have a half second or more of silence between beeps will not be detected.

Other programming options that apply to the microphone include setting the length of time before a high sound causes an alarm.

If this sound level exists for 8 consecutive seconds (default) or for the programmed length of time, the Model 400 will dial out with an alarm message.

NOTE

The proximity of the audible alarm to the microphone is extremely important.

Normally, the Model 400 and the audible alarm must be in the same room. The maximum distance can vary considerably depending on the alarm, the acoustics, and the size of the room.

During an alarm dial-out, the microphone allows four-second intervals to listen-in to sounds at the Model 400's location.

When calling for a Status Report, the microphone permits listening to on-site sounds for a programmed time interval.

2.9 Alert Zones

Open the input/output wiring door located above the keypad. The Model 400 can monitor up to 4 zones (represented by the numbered terminal screws shown in Figure 2-5, below).

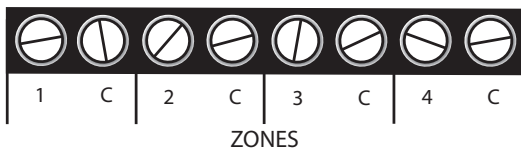

Figure 2-5. Alert Zones

Zones are configured as either dry contact or temperature. A zone configured as dry contact can be used with any normally open (N.O.) or normally closed (N.C.) device. "Open" refers to an opened circuit path; if conditions cause the circuit to close, an alert condition occurs. "Closed" refers to a continuous circuit path; if a closed circuit is opened, an alert condition occurs. The Model 400 determines the way zones are configured by the type of sensor connected to each alert zone (refer to Chapter 5.)

A zone configured as "temperature" is designed to evaluate a range of settings. The Model 400 will read the temperature at the sensor's location and compare that value to programmed high and low temperature limits. Temperature zones must be used with Sensaphone's 2.8K Remote Temperature Sensor or weatherproof sensor.

NOTE

Before wiring, it is advisable to disable the zones to prevent accidentally tripping an alarm. See Chapter 5.

Important Note regarding Ultra-Low temperature freezers:

If you are connecting the Sensaphone to an ultralow temperature freezer (-80° C) and the freezer is equipped with alarm terminals/ contacts you can connect these directly to one of the zones on your Sensaphone (refer to your freezer owner’s manual for proper connection).

2.10 Installing the Sensor

After you have selected the sensor, loosen the screw of the alert zone and its corresponding common (c). Two wire leads are used to connect any monitoring sensor. Fasten one lead to the numbered screw and the other lead to C. Tighten both screws. If the zone was not disabled, the Model 400 may recite its “Alarm Exists” message as you connect the sensor. If it does, just press ALARM CANCEL to stop it. Re-enable the zone after wiring. Refer to Figures 2-6 and 2-7 for connecting a sensor to an alert zone.

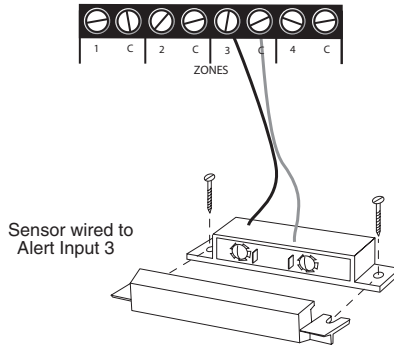

Figure 2-6. Sensor Connected to an Alert Zone

Any sensor can be attached to the Model 400 using 18-26-gauge wire (#22 recommended). The sensor can be several hundred feet from the unit, as long as the total resistance of the circuit is not greater than 50 ohms. Use wire appropriate for the application.

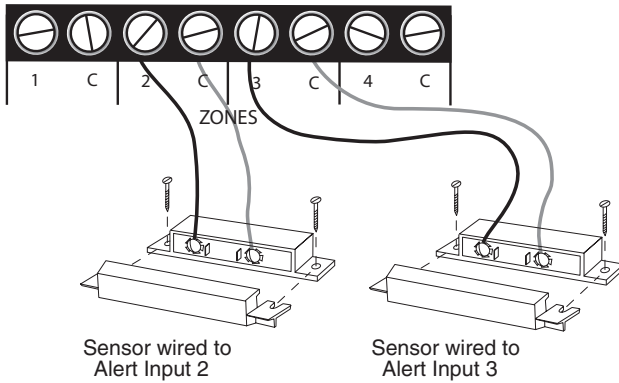

Figure 2-7. Two Sensors Wired to Adjacent Zones

NOTE

Do not use sensors, switches, or relays that supply any voltage or current to the Model 400. Be aware of proximity to other electrical wires or components when placing wires that lead from the sensors to the unit. Avoid running the wires near electrical devices that use high voltage or current, such as motors, heavy machinery, etc. This voltage may be inductively coupled into the sensor wiring and could result in damage to the the Model 400's circuitry. Try to place wires at least 6 inches from other electrical wiring or devices.

2.11 Multiple Sensors

The Model 400 may have more than one sensor connected to the same alert zone, as long as the normal condition for each sensor on the same alert zone is identical (either all N.O. or all N.C.). However, only one remote temperature sensor can be used on each zone.

When wiring several normally closed sensors on one zone, they must be connected in series. Connect one lead from the first sensor to the numbered screw of the alert zone. Next, take the other lead from the first sensor and connect it to one lead from the next sensor. Continue connecting sensors end-to-end until you have connected all of your sensors. Take the second lead from the last sensor and connect it to the common screw on the Model 400.

See Figure 2-8. Multiple N.C. sensors are typically magnetic reed switches to monitor the security of windows and doors.

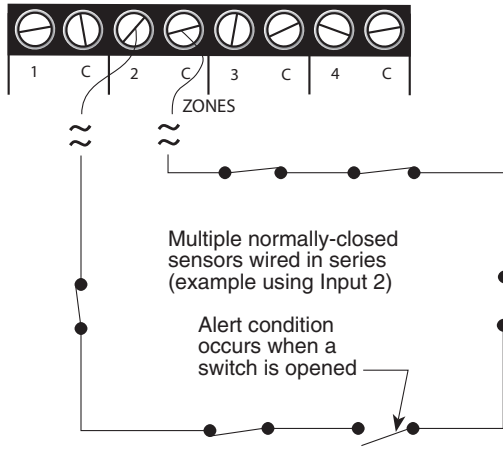

Figure 2-8. Multiple Normally Closed Sensors

To wire several normally open sensors to one alert zone, connect them in parallel. To do this, take one lead from each sensor and attach it to the numbered terminal. Then, take the second lead from each sensor and attach each to the corresponding common screw. Refer to Figure 2-9.

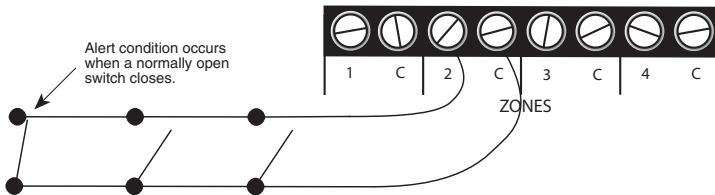

Figure 2-9. Multiple Normally Open Sensors

2.12 Outdoor Wiring

When wiring sensors outdoors, DO NOT allow exposed wires to run freely in open air; under such conditions, the Model

400 is susceptible to serious damage during a lightning storm. Depending upon the distance outdoor wiring must travel, consideration should be given to the use of shielded wire inside a metal conduit. Both shield and conduit should be connected to an earth ground. This prevents stray voltage from entering the unit.

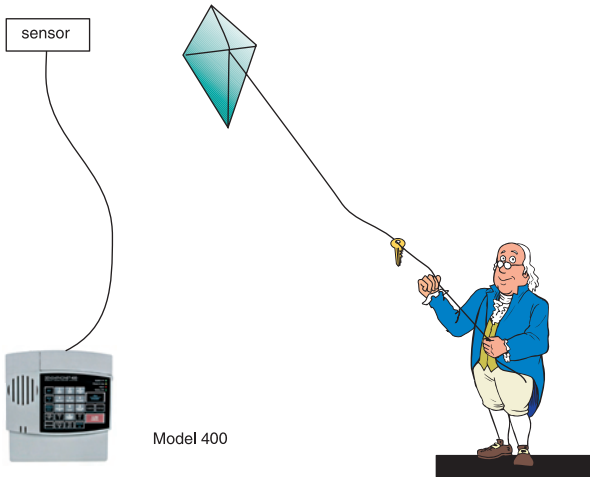

Figure 2-10. Potential Sensor Damage from Stray Electrical Noise

2.13 Disconnecting the Model 400 for Storage or Seasonal Use.

If you plan to employ the Model 400 as a seasonal “watchdog” for a few months during the year, you must disconnect all wires from the unit completely to avoid damage to the circuitry when the unit is not in use. If the unit is unplugged but left in place with all the sensors still connected, the wires act as antennae that draw in any stray “electrical noise” from such devices as fans, blowers, microwaves, etc.

Additionally, it is important to remove the batteries, or they will discharge until they fail.

Preserve your Model 400 during the off-season, or when not in use:

- Remove the sensor wires at the screw terminals
- Remove the batteries
- Unplug the unit and store in a safe place

Chapter 3: Quick Start

This section presents a useful guide for first-time programming of the Model 400. Follow instructions for installation before attempting to program the Model 400. Refer to Chapter 2: Installation.

3.1 The Local Keypad

Programming is accomplished using the local keypad (shown below, Figure 3-1). Notice that a single key has several functions assigned to it; programming results are determined by the order in which keys are pressed.

Individual keystrokes are illustrated to show programming steps in the correct order. If you make a mistake by entering the wrong key, do not press another key until you hear the message “Error 1.” Then, start over with the first key in the programming sequence.

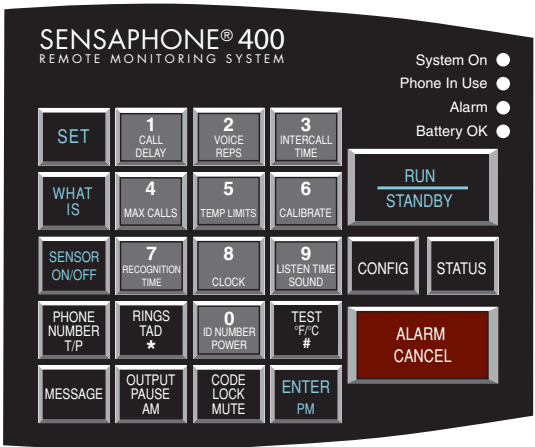

Figure 3-1. The Model 400 Keypad

3.2 Preparation for Programming

Read complete instructions in Chapter 2: Installation, and make sure to follow these three steps first:

1. Plug the AC adapter into the 120 VAC outlet.
2. Install the batteries.
3. Connect the Model 400 to a telephone line.

When these steps are completed, the Model 400 is fully operational and able to monitor temperature, high sound, AC power failure and battery backup condition; it can also be called on the telephone for a Status Report or be used for listening to on-site sounds from any remote location. Now, the unit is ready for programming.

3.3 Quick-Start Programming Steps

Step 1: Set Configuration of Zones

The Model 400 will scan the 4 external zones and determine if they are N.O. (normally open), N.C. (normally closed), or Temperature. If external sensors are added, make sure they are in their normal positions before proceeding—refer to Chapter 5, Section 5.1.

1. Press STANDBY to place the Model 400 in Standby mode.



2. If you have external sensors available, wire the sensors to the zones on the back of the Model 400 (see Chapter 2, Section 2.10). Otherwise, skip this step and move to step 3.
3. Press RUN. The *System On* light glows when the Model 400 returns to Run mode.



4. Press SET.



5. Press CONFIGURE.



6. The Model 400 will audibly recite the new configuration for each of the four zones, responding with “*normally open*”, “*normally closed*”, or “*Temperature.*” If a zone is unused, it is treated as normally open.

Step 2: Set the ID Number

It is recommended that you set the ID number to reflect the telephone number on which the Model 400 is installed.

1. Press SET



2. Press ID NUMBER.



3. Using the number keys, enter the digits (up to 16 are permitted) for the ID number. The Model 400 will recite the digits as they are pressed.

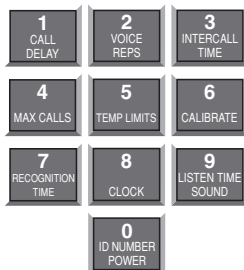

4. Press ENTER. The 400 will respond: "Okay."



Step 3: Set Dial-Out Telephone Numbers

To program dial-out telephone numbers:

1. Press SET.



2. Press PHONE NUMBER.



3. Select which telephone number to program. Press any unassigned number key (from 1 to 8) to represent the new telephone number entry. Model 400 will respond: "Enter number."



4. Enter the complete telephone number using the number keys.
The Model 400 will recite the digits as they are pressed.

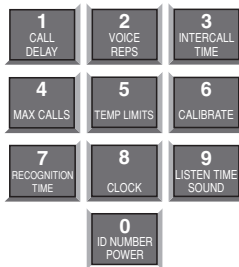

5. Press ENTER. The unit will respond: "Okay."



6. Repeat above procedure to program up to four separate telephone numbers.

Step 4: Set Temperature Limits

High and low temperature limits can be separately programmed for each zone that is configured as temperature. Limits can range from -20° to $+150^{\circ}$ Fahrenheit, or from -30° to 65° Celsius. Default settings are: 10° F for low temperature and 100° F for high temperature. Do not set temperature limits too close to normal room temperature, since minor fluctuations could result in frequent and unnecessary alarm dialouts.

1. Press SET.



2. Press TEMP LIMITS.



3. Using the number keys, press a number (from 1 to 4) that corresponds to the temperature zone being programmed.



The Model 400 responds: *“Enter low temperature limit.”*

4. Using the number keys, enter a value for low temperature limit. The Model 400 will recite the digits as they are pressed. If a negative number is required, first press *, then enter the number.



5. Press ENTER.



The Model 400 responds: *“Enter high temperature limit.”*

- Using the number keys, enter the value for high temperature limit. The Model 400 will recite the digits as they are pressed.



- Press ENTER. The Model 400 responds: “Enter.”



This concludes minimum programming to achieve normal operation of the Model 400. In addition to the programming just accomplished, default settings for many more features take effect when the unit is first powered. You will be able to reprogram most of these factory-set defaults to suit your application.

For a complete explanation of each feature (with illustrations of keystrokes), refer to Chapter 4: Communications Programming and Chapter 5: Alarm Programming.

To gain a basic understanding of how the alarm dial-out feature works, refer to this chapter, Section 3-4. For extended information regarding dial-out and related programmable parameters, refer to Chapter 7: Operation.

3.4 Summary of the Alarm Dial-Out Process

Action—Response	Programmable Feature
<p>1. THE MODEL 400 DETECTS AN ALERT CONDITION</p> <p>An alert condition is not the same as a valid alarm—the condition must continue for the programmed time period, or <i>Recognition Time</i>, before it is recognized as a valid alarm.</p> <p>2. A VALID ALARM IS CONFIRMED</p> <p>An audible, on-site alarm message begins and continues until the alarm is acknowledged. (If the Mute feature is turned on, there is no on-site message.) <i>Call Delay</i> is activated.</p> <p>3. DIAL-OUT BEGINS</p> <p>Dial-out begins by calling telephone number 1 to report an alarm. If there is no acknowledgment, the Model 400 waits the programmed <i>Intercall Time</i> before dialing subsequent telephone numbers. Dial-out continues in this manner, cycling through the remaining telephone numbers, for the programmed <i>Max Calls</i>.</p> <p>4. THE ALARM IS ACKNOWLEDGED</p> <p>When the alarm is acknowledged, the dial-out process is cancelled and the audible, on-site alarm message stops.</p>	<ul style="list-style-type: none"> • Recognition Time This is the programmed waiting period to determine if an alert condition has persisted long enough to be considered a valid alarm. If the sensor returns to normal within recognition time, then no alarm will occur. • Call Delay This is the programmed waiting period, before the first telephone number is called, to report an alarm. • Intercall Time This is the programmed waiting period, in between sequential dialing of telephone numbers, to report an alarm. • Max Calls This is the total number of telephone calls that will be dialed in response to any valid alarm. Telephone numbers are dialed sequentially, and continue to cycle until the maximum number of calls is reached. If no acknowledgment occurs, then at the completion of Max Calls, all alarms are automatically acknowledged.

Chapter 4: Communications Programming

This chapter explains the keypad commands for communications programming of the Model 400, including interrogation and resetting of the following:

- Voice Messages
- The Unit ID Number
- Dial-out Telephone Numbers
- Tone or Pulse Dialing
- Special Dialing with Pagers, Beepers and Access Numbers.
- Dial-out test mode
- Rings Until Answer
- Telephone Answering Device Compatibility
- Listen-in Time
- Call Delay
- Local Voice Mute
- Voice Repetitions
- Intercall Time
- Maximum Number of Calls
- The Clock
- Security Code

4.1 Voice Messages

The 400's digital speech recording feature allows you to record custom messages for each of the four Zones and an ID Message. This means that when the 400 calls you during an alarm, you will hear a personalized Voice Message identifying the unit and telling you exactly what alarm condition exists. You can record a separate message for each of the four Zones. The message can run a maximum of 5 seconds. The ID Message can be a maximum of 8 seconds. You can shorten the message length by pressing the ENTER key after reciting the message.

The **ID Message** is used to identify the unit. This could be a particular building name, its location (address or city), or some other identifier.

To program the ID Message:

1. Press the SET key.



2. Press the MESSAGE key. The 400 will say “Enter Message Number.”



3. Press the ID key (number 0 key).

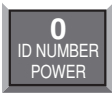

4. When the unit beeps, begin speaking your message into the microphone. The unit will say “OK,” when the recording time has elapsed; then it will play back your recorded message.

To play back the ID Message:

1. Press the WHAT IS key.



2. Press the MESSAGE key.



3. Press the ID key (number 0 key).

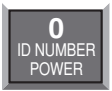

The 400 will play back your recorded message.

The **Zone Messages** are used to identify the device or condition being monitored such as temperature, humidity, equipment alarms, security alarms, etc.

To program the Voice Message for a Zone:

1. Press the SET key.



2. Press the MESSAGE key. The 400 will say, "Enter Message Number."



3. Press the number key for the corresponding Zone.



4. When the unit beeps, begin speaking your message into the microphone. The unit will say "OK," when the recording time has elapsed; then it will play back your recorded message.

To play back the message for a Zone:

1. Press the WHAT IS key.



2. Press the MESSAGE key.



3. Press the corresponding Zone number key.



The 400 will play back your recorded message.

To erase a Zone or ID message:

1. Press the SENSOR ON/OFF key.

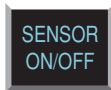

2. Press the MESSAGE key.

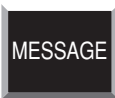

The 400 will say “Enter message number.”

3. Press the Zone Number or ID key.



The 400 will say, “Message erased.”

4.2 The Unit ID Number

The Unit ID Number is the identification number of the Model 400. This number is typically the telephone number where the unit is installed, or it may be designated using any number that best suits your application.

The purpose of the Unit ID Number is to immediately provide the source of any alarm, especially when using multiple Model 400

units in a complex monitoring system. When the Model 400 is called from a remote location, it always begins its message with the identification number:

“Hello, this is (Unit ID Number).”

4.2.1 Programming the ID Number

To program the ID Number:

1. Press SET.



2. Press ID NUMBER.



3. Using the number keys, enter up to 16 digits for the ID number. The Model 400 will recite the digits as they are pressed.



4. Press ENTER. The Model 400 will respond: *“Okay.”*



4.2.2 Interrogating the ID Number

To interrogate the ID numbers:

1. Press WHAT IS.



2. Press ID NUMBER. The Model 400 will recite the Unit ID Number programmed.



4.3 Dial-out Telephone Numbers

The Model 400 can store up to four 48-digit phone numbers. These are the numbers that will be called during alarm dial-out. In the event of an alarm, the numbers are dialed sequentially, 1 through 4. Begin programming the first telephone number by assigning it to the key labeled with the number 1 on the keypad, and continue to assign any other telephone numbers in numerical order. *A pause, pound or star* can be added to an individual phone number to access different phone and beeper systems. See *Special Dialing, Section 4.5*.

4.3.1 Programming Dial-out Telephone Numbers

To program dial-out telephone numbers:

1. Press SET.



2. Press PHONE NUMBER.



3. Select which telephone number to program. Press any unassigned number key (from 1 to 4) to represent the new telephone number entry. The Model 400 will respond: "Enter number."



4. Enter the complete telephone number using the number keys.



5. Press ENTER. The unit will respond with “Okay.”



6. Repeat above procedure to program up to four separate telephone numbers.

4.3.2 Interrogating a Dial-out Telephone Number

To interrogate dial-out telephone numbers:

1. Press WHAT IS.



2. Press PHONE NUMBER.



3. Press a number key (from 1 to 4).



Model 400 will recite the corresponding telephone number. If there is no number programmed for a particular key, the unit will respond: “No number.”

4.3.3 Erasing a Telephone Number

To erase a telephone number:

1. Press SET.



2. Press PHONE NUMBER.



3. Press the number key (from 1 to 4) representing the telephone number you want to erase.



4. Press ENTER. The Model 400 will say “Number # erased.”



4.4 Tone or Pulse Dialing

The Model 400 can dial out in pulse or Touch Tone™. Select the type of dialing, in either pulse or tone, depending upon the type of service provided by your telephone company. The default is tone.

To program for either pulse or tone:

1. Press the SENSOR ON/OFF key.



2. Press PHONE NUMBER T/P.



The Model 400 will respond: “Tone” to indicate that tone dialing is enabled, or “Pulse” to indicate that pulse dialing is on and enabled.

3. Repeat key sequence to switch between settings.

4.5 Special Dialing

The Model 400 has provisions for special dialing sequences. Special dialing sequences allow:

- Dialing that requires an access number to connect with an outside line.
- Dialing that requires the pound (#) or star (*).
- Dialing to a beeper or pager.

4.5.1 Special Dialing Keys

The following designated keys represent special functions when used with PHONE NUMBER entries:

1. *Pause*



PAUSE represents a two-second pause in dialing. It can be used when an access number is required before dialing to an outside line. (For example, in some cases a “9” or other number, must be dialed first, in order to get a dial tone for an outside line.)

2. *Pound (#)*



A pound may be required when calling some phone or beeper systems.

3. *Star (*)*



A star may be required when calling some phone or beeper systems.

4. *Code*



The CODE key can be used to perform special functions during the dialing sequence. These include: Pager dialing, Wait for Answer, and Switch to Touch-tones. These functions enable the Sensaphone to send a numeric page, or dial a telephone number + office extension, or combine pulse & touch-tone dialing in the same telephone number. Multiple codes can be used during telephone number programming if required. See section 4.5.4 for special instructions on dialing to a beeper or pager.

Code 1 Pager

When CODE + 1 is inserted as the first digit of the telephone number, the Model 400 will make a pager call. This means that the unit will expect the call to be answered by a paging service provider, then it will send its ID number (using touch-tones), followed by the digits that identify the zone(s) in alarm. The unit will hang-up after it completes the call. See section 4.5.4 for specific programming examples for dialing a pager.

Code 2 Wait-For-Answer

You can force your Sensaphone to Wait-For-Answer in the middle of dialing a telephone number. This is useful when calling a telephone extension that is initially answered by an auto-attendant. By inserting the wait-for-answer code you can instruct your Sensaphone to call the main number, then wait for an answer by the auto-attendant, then dial the extension. The Sensaphone will not speak its voice message until the telephone is answered at the extension.

Example:

SET + PHONE NUMBER + any unassigned number key 1-4
+ telephone number + CODE + 2 + extension number + ENTER

Code 3 Switch to Touch-tone

This command allows you to change from pulse dialing to touch-tone dialing in the middle of dialing a telephone number. This is useful when your telephone service only supports pulse dialing, but you need to send touch-ones after connecting – such as when dialing a numeric pager or navigating a voice menu.

Example:

In this example a telephone number is dialed, the Sensaphone waits for the call to be answered, then changes to touch-tones to dial an extension.

SET + PHONE NUMBER + any unassigned number key 1-4 +
telephone number + CODE + 2 + CODE + 3 +
extension number + ENTER

4.5.2 Incorporating a Pause

Incorporate PAUSE to access an outside telephone line:

1. Press SET.



2. Press PHONE NUMBER.



3. Press any unassigned number key (from 1 to 4) to represent the new telephone number entry. Model 400 will respond: *“Enter number.”*



4. From the number keys, enter the access digit (i.e., 9). The Model 400 will recite the digit.



5. Press PAUSE. The Model 400 will *“pause.”*



6. Enter the complete telephone number using the number keys. The Model 400 will recite the digits as they are pressed.



7. Press ENTER. The Model 400 will say "Okay."



4.5.3 Incorporating a Pound (#) or Star (*)

Incorporate a pound or star if it is normally included in telephone number:

1. Press SET.



2. Press PHONE NUMBER.



3. Press any unassigned number key (from 1 to 4) to represent the new telephone number entry. Model 400 will respond: "Enter number."



4. Enter the telephone number using the number keys. The Model 400 will recite the digits as they are pressed.



5. Position the pound (#) or star (*) within the telephone number where required by pressing the designated keys. The Model 400 will say "pound" or "star" each time the key is pressed.



-OR-



6. Enter any remaining digits of the telephone number.
7. Press ENTER. The Model 400 will say "Enter."



4.5.4 Special Dialing to a Beeper or Pager

Your Sensaphone can be programmed to send an alarm message to a numeric beeper/pager. The message will include the Sensaphone's telephone number (ID number) and the Zone numbers that are in alarm. For example, if zones 1 and 4 are in alarm, the message on your pager would be: 8882227777-1-4, where 8882227777 is the unit's ID number. A Sound alarm will appear as alarm -9 and a Power alarm will appear as alarm -0. To program a telephone number for Pager dialout, you must enter Code 1 at the beginning of the telephone number. The Sensaphone will say "Code one, Pager" when you enter the command.

Follow the key sequence below to dial a numeric pager:

SET + PHONE NUMBER + any unassigned number key 1-4 +
CODE + 1 + pager telephone number + ENTER

To check your programming:

WHAT IS + PHONE NUMBER + assigned # 1-4

The Sensaphone will say "Pager", followed by the programmed telephone number.

To send a test page:

SET + TEST + assigned # key 1-4 + ENTER

The Sensaphone will let you listen to the dialout sequence through its speaker and send you a message that includes the Sensaphone's telephone number (ID number).

Voice Prompted Paging Systems

If your paging provider is answered by a voice prompt which requires you to enter one or more touch-tones to send a message, then use the wait-for-answer code (4.5.1) in combination with the Pause key and other number keys to navigate the voice menu until you reach the message entry point. The Sensaphone will automatically send it's telephone number, Zone numbers, and a pound (#) tone at the end of the number. For assistance contact Sensaphone Technical Support at 1(877)373-2700.

4.6 Rings Until Answer

Rings Until Answer is the programmed number of times the telephone rings before the Model 400 will answer an incoming call. This can be set from 1 to 15 rings. The default value is 4.

4.6.1 Programming Rings Until Answer

To program Rings Until Answer:

1. Press SET.



2. Press RINGS/TAD. The Model 400 will respond: "Enter number."



3. Using the number keys, enter a value.



4. Press ENTER. The Model 400 will respond: "Okay."



4.6.2 Interrogating Rings Until Answer

To interrogate Rings Until Answer:

1. Press WHAT IS.



2. Press RINGS/TAD.



4.7 TAD (Telephone Answering Device)

The TAD feature is especially useful because it integrates the operation of the Model 400 with your telephone answering device (e.g. answering machine) in a way that retains the full flexibility of each system. This allows you to have on-demand telephone access to the Model 400, for obtaining a Status Report, or for issuing call-in commands, while your telephone answering device is set to receive outside calls. Programming for use with a telephone answering device (TAD) is always used in conjunction with Rings Until Answer, detailed in section 4.6.

NOTE

The TAD feature only applies to answering devices connected to the same telephone line as the Model 400.

4.7.1 TAD Enable/Disable

To enable/disable the TAD feature:

1. Press SENSOR ON/OFF.



2. Press RINGS/TAD.



The Model 400 will respond: “TAD On.” (If the Model 400 says “TAD Off,” repeat steps 1 and 2 to reactivate TAD.)

4.7.2 Using the TAD Feature

1. Make sure the TAD feature is enabled on the Model 400. (The default setting is disabled, so you must enable it first.)
2. Determine the number of rings your telephone answering device uses to answer the telephone. (Most answering devices require 4 rings; others are selectable.)
3. On the Model 400, program Rings Until Answer to a greater number than the number of rings set on your answering machine.

Example:

Telephone answering device, rings = 4

Model 400, Rings Until Answer = 6

Using the procedure just outlined, all incoming calls will be answered by the telephone answering device, allowing it to operate normally. With the programming just accomplished, the Model 400 can be accessed remotely, by telephone, to obtain the Status Report.

1. Dial the telephone number of the Model 400.
2. Let the telephone ring once and then hang up.
3. Wait approximately ten seconds
4. Call the Model 400 back.

It will answer the telephone on the first ring.

Explanation: The pattern of one ring, followed by a second call (within 30 seconds), signals the Model 400 to answer your incoming call, bypassing the telephone answering device.

NOTE

Special Case: If the Model 400 shares the same line with a telephone answering device, and during certain time periods, frequent, incoming calls are expected on that line, then you may want to temporarily disable the TAD feature. If you leave the TAD enabled, it will not adversely affect normal operation, but if two outside telephone calls are received within the same 30-second time window, the Model 400 will interpret this pattern as a signal to answer the telephone. If this occurs, press any key on the Model 400 to hang up.

4.7.3 No TAD In Use

If a telephone answering device is not used on the same telephone line as the Model 400, make sure that the TAD feature is disabled, or turned off. Only Rings Until Answer programming will determine how incoming calls are answered. For example, if you program Rings Until Answer to 3, incoming calls will be answered in 3 rings.

4.8 Listen-in Time

The Listen-in Time is the amount of time you can listen to sounds from the Model 400's built-in microphone at its installation site. When you call in for a Status Report, the Model 400 announces Listen-in Time at the end of its first round of status readings, saying, "*Listen for (programmed time entered).*" The programmable range is from 0 to 255 seconds (or up to 4.17 minutes). The default value is 15 seconds.

NOTE

The microphone is also used to monitor high sound level. See Chapter 5, Section 5.10 through Section 5.11.1.

4.8.1 Programming the Listen-in Time

To program the Listen-in Time:

1. Press SET.



2. Press LISTEN TIME. The Model 400 will respond: "*Enter seconds.*"



3. Using the number keys, enter the seconds. The Model 400 will recite the digits as they are pressed.

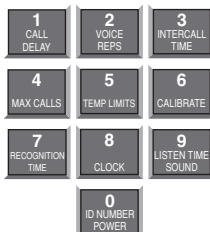

4. Press ENTER. The Model 400 will respond: "Okay."



4.8.2 Interrogating the Listen-in Time

To interrogate the Listen-in Time:

1. Press WHAT IS.



2. Press LISTEN TIME. The Model 400 will recite the listen-in time.



4.9 Call Delay

Call Delay is the programmed length of time the Model 400 waits, following detection of an alarm, before it begins the dial-out sequence. This applies only to the first call. (Delay time between calls is also programmable: refer to Intercall Time, Section 4-12.)

The purpose for Call Delay is to allow time for personnel at the Model 400's installation site to respond to and cancel an alarm before dial-out begins. During this time, the Model 400 will audibly repeat its "alarm" message (unless the Local Voice Mute feature has been activated—refer to Section 4.10). The default for Call Delay is 30 seconds. Call Delay can be programmed from 0 seconds to 60 minutes (1 hour).

4.9.1 Programming the Call Delay

To program the Call Delay:

1. Press SET.



2. Press CALL DELAY.



The Model 400 will respond: “Enter minutes.”

- Using the number keys, enter the minutes.



The Model 400 recites the digits as they are pressed.

- Press ENTER. The Model 400 responds: “Enter seconds.”



- Using the number keys, enter the seconds. The Model 400 recites the digits as you press them.
- Press ENTER. The Model 400 responds: “Okay.”



4.9.2 Interrogating Call Delay

To interrogate Call Delay:

- Press WHAT IS.



- Press CALL DELAY.



The Model 400 will recite the programmed Call Delay.

4.10 Local Voice Mute

When the Model 400 dials out to report an alarm, it also audibly recites the alarm message through its speaker. The Local Voice Mute command allows you to turn off the speaker at the Model 400's site during alarm dialouts and status call-ins. This feature

is used to prevent intruders or unauthorized persons from hearing the alarm dial-out message or from hearing the Status Report during an off-site call.

4.10.1 Enable/Disable Local Voice Mute

To enable/disable Local Voice Mute:

1. Press SENSOR ON/OFF.

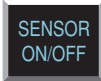

2. Press MUTE.



The Model 400 will say “*Mute On*” to indicate that Local Voice Mute is enabled, or “*Mute Off*” to indicate that it is disabled.

3. Repeat key sequence to switch between enabled or disabled Local Voice Mute.

4.11 Voice Repetitions

The Voice Repetitions feature allows programming of the number of times the alarm message is repeated *per phone call* during alarm dial-out.

The maximum repetitions may be set to 10; the default is 3 repetitions.

4.11.1 Programming Voice Repetitions

To program Voice Repetitions:

1. Press SET.



2. Press VOICE REPS.



The Model 400 will respond: “*Enter number.*”

- Using the number keys, enter a value from 1 to 10.

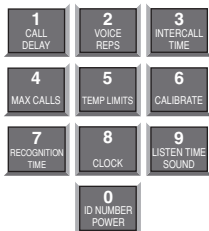

- Press ENTER. The Model 400 will respond: "Okay."



4.11.2 Interrogating Voice Repetitions

To interrogate Voice Repetitions:

- Press WHAT IS.



- Press VOICE REPS.



The Model 400 will recite the number programmed.

4.12 Intercall Time

The Intercall Time is the programmable period of time the Model 400 waits in calling subsequent telephone numbers. Intercall Time is activated ***only after alarm dial-out to the first telephone number fails to be acknowledged***. This period can be programmed from 10 seconds to 60 minutes. The default intercall time is 1 minute.

If an incoming telephone call is made to the Model 400 during Intercall Time (in between its dialing of subsequent telephone numbers to report an alarm), it will answer the incoming call and immediately report any existing alarms.

4.12.1 Programming Intercall Time

To program Intercall Time:

1. Press SET.



2. Press INTERCALL TIME.



The Model 400 will respond: *"Enter minutes."*

3. Using the number keys, enter the minutes.



The Model 400 recites the digits as you press them.

4. Press ENTER. The Model 400 will respond: *"Enter seconds."*



5. Using the number keys, enter the seconds. The Model 400 recites the digits as you press them.



6. Press ENTER. The Model 400 responds: *"Okay."*

4.12.2 Interrogating Intercall Time

To interrogate Intercall Time:

1. Press WHAT IS.



2. Press INTERCALL TIME.



The Model 400 will recite the programmed Intercall Time.

4.13 Maximum Number of Calls (Max Calls)

The Max Calls feature controls the total number of repeated calling attempts by the Model 400 in the event of an alarm. When an alarm occurs, the dial-out process begins, and continues to cycle through your programmed telephone numbers until the alarm is acknowledged or until the maximum number of calls is reached. The Max Calls setting regulates the number of calls that will be made as a result of any alarms; if more than one alarm is detected at once, or if a second alarm occurs during dial-out on the first alarm, the Max Calls setting will start the calling process from zero, until the programmed number of calling attempts are completed.

The default setting for Max Calls is 100, but it may be programmed from 1 to 255 calls. Max Calls is cancelled when an alarm is acknowledged. If the maximum number of calls is completed and no alarm acknowledgement has occurred, the Model 400 will automatically acknowledge any alarm and stop the dial-out.

NOTE

If only one telephone number is programmed, the Model 400 will dial out a maximum of 15 times to report an alarm in accordance with FCC rules.

4.13.1 Programming Max Calls

To program Max Calls:

1. Press SET.



2. Press MAX CALLS.



The Model 400 will respond: "Enter number."

3. Using the number keys, enter a value. The Model 400 will recite the digits as you press them.

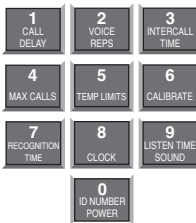

4. Press ENTER. The Model 400 responds: "Okay."



4.13.2 Interrogating Max Calls

To interrogate Max Calls:

1. Press WHAT IS.



2. Press MAX CALLS.



The Model 400 will recite the value set for Max Calls.

4.14 The Clock

The Model 400 has a built-in clock. The power-up time is 12 AM. The clock will keep time from 12 AM until you program the current time. It will then keep time from your programmed time. If the AC power fails, the clock will continue to keep time until the battery back-up fails. It will then reset to 12 AM when power is restored. *An incorrect time is a good indication that the power has failed and the batteries have been expended.*

4.14.1 Setting the Clock

To set the clock:

1. Press SET.



2. Press CLOCK.



3. Using the number keys, enter the correct time. The Model 400 will recite the digits as they are pressed.



4. If the time is AM, press the AM key. The Model 400 will say “am” If the time is PM , press the PM key. The Model 400 will say “pm.”



Example: You want to set the clock to 9:45 AM. Press the following keys in the order shown:

SET + CLOCK + 9 + 4 + 5 + AM

4.14.2 Interrogating for the Current Time

To interrogate the Model 400 for the current time:

1. Press WHAT IS.



2. Press CLOCK. The Model 400 will recite the current time.

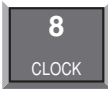

4.15 The Security Code

The Security Code is the last step after setting all other programming parameters for the Model 400. The code consists of a 4-digit number you select and will effectively prevent unauthorized changes to the Model 400's programming. When the Security Code is activated, all keyboard programming is locked. The Model 400 may be interrogated using the WHAT IS key, but the keyboard must be unlocked, via the Security Code, before any programming changes are possible.

4.15.1 Locking the Keypad

To program the Security Code:

1. Press SET.



2. Press CODE.



The Model 400 will say "Enter security code."

3. Using the number keys, enter 4 digits.
4. Press ENTER.



The Model 400 says, "OK." The keyboard is now locked.

If unauthorized persons attempt to set a parameter, an error message, “*Error 2,*” is returned. Whenever any operation except WHAT IS takes place without entering the security code first, this error message occurs.

4.15.2 Unlocking the Keypad

To unlock the keyboard:

1. Press WHAT IS.



2. Press CODE.



The Model 400 will say “*Enter Security Code.*”

3. Using the number keys, enter the digits for the code.

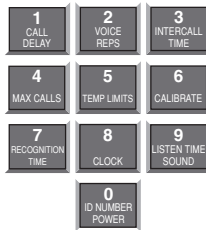

4. Press ENTER.



If the correct code is entered, the Model 400 will say “*OK.*” If the wrong code is entered, the Model 400 will say “*Error 2.*”

Chapter 5: Alarm Programming

This chapter explains the alarm programming and monitoring capabilities of the Model 400, with specific instructions for the following features:

- Configure zones as dry contact or temperature
- Enable/disable zones
- Program alarm Recognition Time for each zone
- Program high and low temperature limits
- Disable alarm response to high or low temperature
- Program temperature in Fahrenheit or Celsius scale
- Calibrate temperature
- Obtain current temperature
- Program AC power-failure Recognition Time
- Enable/disable AC power monitoring
- Program sound level sensitivity
- Program high sound Recognition Time
- Disable alarm response to high sound
- Use Exit Delay via Status Report

5.1 Zone Configuration

In preparing the Model 400 to sense an alert condition, the zones must be configured as dry contact (either open or closed) or as temperature zones. The default setting for zone 1 is temperature; for zones 2-4, the default is dry contact and open. To configure zone normality, sensors are first wired to the terminal strip at the back of the unit. (Refer to Chapter 2, Section 2.9–2.12, for an explanation on wiring zones.)

The configuration process directs the Model 400 to initialize the 4 zones and establish normal settings. Any change in the status of a zone (for example, from a normally open contact to a suddenly closed contact) is recognized as an **alert condition**. In the case of a temperature zone, an alert condition is recognized when established temperature limits are exceeded.

NOTE

Before starting keyboard commands to configure zone normality on the Model 400, ***it is very important to check that the sensors you have wired to the unit are set in their normal, non-alarm positions.***

For example, if a magnetic reed switch (a normally-closed sensor used to detect unauthorized entry) has been wired to the Model 400, make sure that the door or window to be monitored is shut before configuring the zone. If a motion-detector is wired to the unit, it is advisable to block all sources of motion from the sensor before and during configuration.

5.1.1 Programming Zone Configuration

1. Press STANDBY to place the Model 400 in Standby mode.

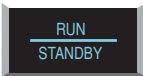

2. Wire sensors to the zones to the back of the Model 400 (see Chapter 2, Section 2.10).
3. Press RUN. The red light glows when the Model 400 returns to Run mode.

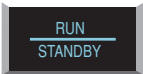

4. Press SET.



5. Press CONFIG.



6. The Model 400 audibly recites the configuration for each of the four zones:

- If the zone is **open**, the Model 400 recites the number of the zone and says “*normally open.*”
- If the zone is **closed**, the Model 400 recites the number of the zone, and says “*normally closed.*”
- If the zone is configured as **temperature**, the Model 400 recites the number of the zone, followed by “*Temperature.*”

5.1.2 Interrogating Zone Configuration

1. Press WHAT IS.



2. Press CONFIG.



The Model 400 will audibly recite the configuration of each zone.

5.2 Enable/Disable Zones

This function allows you to enable or disable a zone's response to an alert condition. An enabled zone will respond to an alert condition and allow dial-out. A disabled zone will cause dial-out to be suppressed, but any existing alert conditions will be revealed during the Status Report. Enable/disable programming is useful during wiring of zones (see Chapter 2) or when a condition needs to be monitored, but is not critical enough to be programmed for dial-out reporting. It is important to verify zone status after performing any task that requires disabling. The default setting for all zones is enabled (ON).

If an alert condition exists when zones are re-enabled, Recognition Time will restart—refer to Section 5.3.

5.2.1 Changing Enabled/Disabled Zone Status

1. Press SENSOR ON/OFF.



2. Press the number (1 to 4) of the selected zone to enable/disable. The Model 400 says “*Alarm Disabled*” to indicate disabled or “*Alarm Enabled*” to indicate enabled.



5.2.2 Verifying Enabled/Disabled Zone Status

1. Press WHAT IS.



2. Press STATUS.



The Model 400 audibly recites the current status of every zone. In a Status Report, each zone is first identified by its zone number, followed by a report that specifies parameters currently affecting that zone. ***If a zone is disabled, the word “Alarm Disabled” immediately follows the number recited for that zone.***

For example, zone 3 is configured as a normally open, dry contact zone. During the Status Report:

- ***If disabled***, the Model 400 recites:
“Zone 3, the Alarm is Disabled” for zone 3.
- ***If enabled***, the Model 400 recites:
“Zone 3—OK,” for zone 3.

In another example, zone 2 is configured as a temperature zone. The current temperature is 76 degrees. During a Status Report:

- ***If disabled***, the Model 400 recites:
“Zone 2, the alarm is disabled, it is now 76 degrees fahrenheit—OK”
- ***If enabled***, the Model 400 recites:
“Zone 2—76 degrees fahrenheit—OK.”

5.3 Zone Recognition Time

The Zone Recognition Time is the length of time an alert condition must be present before a valid alarm exists and dial-out is activated. This time period is programmable, from 0 minutes, 0 seconds (for immediate response) up to a period of 540 minutes, 0 seconds. If an alert condition begins and then clears within the established Recognition Time, no dial-out will occur. When an alert condition continues beyond the programmed Recognition Time, the Model 400 initiates dial-out. The default setting for Zone Recognition Time is 0 minutes, 3 seconds.

5.3.1 Programming Zone Recognition Time

1. Press SET.



2. Press RECOGNITION TIME.



3. Press the number (1 to 4) of the selected zone to be programmed.



The Model 400 responds: *“Enter minutes.”*

4. Using the number keys, enter the minutes. For example, to set a Recognition Time of five minutes, simply press “5” on the keypad. The Model 400 recites the digits as they are pressed.



5. Press ENTER. The Model 400 responds: *“Enter seconds.”*



- Using the number keys, enter the seconds. The Model 400 recites the digits as they are pressed.



- Press ENTER. The Model 400 responds: "Okay."



5.3.2 Interrogating Zone Recognition Time

- Press WHAT IS.



- Press RECOGNITION TIME.



- Press the corresponding zone key (1 to 4).



The Model 400 recites the programmed Recognition Time for that zone.

5.4 Establishing High and Low Temperature Limits

High and low temperature limits can be separately programmed for each zone configured as temperature. Limits can range from -20° to $+150^{\circ}$ Fahrenheit, or from -30° to 65° Celsius.

When temperature limits exceed high or low settings, the Model 400 will dial out with an alarm message. Default settings are: 10° F for low temperature and 100° F for high temperature.

5.4.1 Programming Temperature Limits for a Selected Zone

1. Press SET.



2. Press TEMP LIMITS.



3. From the number keys, press a number (from 1 to 4) that corresponds to the temperature zone being programmed.



The Model 400 responds: *“Enter low temperature limit.”*

4. Using the number keys, enter a value for low temperature limit. The Model 400 will recite the digits as they are pressed. If a negative number is required, first press *, then enter the number.

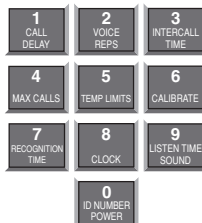

5. Press ENTER.



The Model 400 responds: “Enter high temperature limit.”

6. Using the number keys, enter the value for high temperature limit. The Model 400 recites the digits as they are pressed.



7. Press ENTER. The Model 400 responds: “Enter.”



NOTE

Do not set temperature limits too close to normal room temperature. Minor temperature fluctuations could result in frequent and unnecessary alarm dialouts.

5.4.2 Disabling Alarm Response to High or Low Temperature

To disable alarm response to either high or low temperature settings exclusively, enter the following temperature limit when programming the selected zone. (The Model 400 will not respond to temperatures encountered at maximum settings or beyond.) Begin by following the key sequence shown in Section 5.4.1, and when prompted to enter the high or low temperature value:

- Set high temperature to either +150° F or +65° C (high temperature limit) to prevent the Model 400 from responding to a high temperature alarm.
- Set low temperature to either -20° F or -30° C to prevent the Model 400 from responding to a low temperature alarm.

5.4.3 Interrogating High and Low Temperature Limits

1. Press WHAT IS.



2. Press TEMP LIMITS.



3. Press the number key corresponding to the selected temperature zone.



5.5 Temperature Scale

Temperature zones may be set in either Fahrenheit or Celsius degrees. The default temperature scale is Fahrenheit. To change to Celsius:

1. Press SENSOR ON/OFF.



2. Press °F / °C. The Model 400 responds: “*Degrees Celsius*” indicating Celsius scale has replaced Fahrenheit scale.



3. To return to Fahrenheit scale, repeat the key sequence. The Model 400 responds: “*Degrees Fahrenheit*” indicating Fahrenheit scale is in effect.

NOTE

When switching from Fahrenheit to Celsius, or vice versa, the change applies to all zones configured to read temperature. When switching temperature scales it is important to reset high and low temperature limits on all temperature zones. Refer to Section 5.4.1 to reset temperature limits.

5.6 Temperature Calibration

To compensate for minor variances in sensor accuracy, an offset may be programmed for each temperature zone. The amount of offset is measured in degrees Fahrenheit or degrees Celsius. Adjustments are possible within a range from -10 degrees to +10 degrees. For example, if zone 3 is sensing temperature and is reading 1 degree too high, then the calibration for zone 3 is set at -1 to obtain an accurate reading.

5.6.1 Programming Temperature Calibration

1. Press SET.



2. Press CALIBRATE.



3. Press the number (1 to 4) of the selected temperature zone to be calibrated.



4. Enter the number required to offset the current temperature reading so a correct reading is obtained.

- To program a positive offset number (up to +10 degrees), enter the number on the keypad. The Model 400 recites the digits as they are pressed.
- To program a negative offset number (up to -10 degrees), first press *. The unit responds with "negative." Next, enter the number on the keypad. The unit recites the digits as they are pressed.

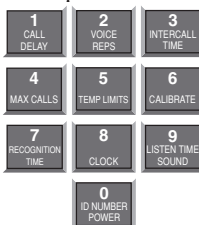

5. Press ENTER. The Model 400 responds: "Okay."



NOTE

If you find that your calibration offset exceeds more than + 5 or -5 degrees, other complicating factors could be affecting normal operation of the Model 400. Call Sensaphone for technical assistance.

5.6.2 Interrogating Temperature Calibration

1. Press WHAT IS.



2. Press CALIBRATE.



3. Press the number key corresponding to the selected temperature zone.



5.7 Obtaining Current Temperature

Current temperature readings for each temperature zone may be accessed at any time. The Model 400 recites the zone number, and the actual temperature detected by the attached sensor, for all zones configured as temperature. To obtain current temperature:

1. Press WHAT IS.



2. Press TEST °F/°C.



5.8 AC Power Monitoring Enable/Disable

The Model 400 monitors AC power failure. This command enables or disables the power failure detection feature. When enabled, the Model 400 will monitor power and dial out when AC power failure exceeds a programmable span of time (refer to AC Power Failure Recognition Time, Section 5.9).

The default setting for AC power monitoring is enabled (on). When disabled, the Model 400 will not dial-out to report power failure.

5.8.1 Enabling/Disabling the AC Power Alarm

1. Press SENSOR ON/OFF.



2. Press POWER.



- The Model 400 will say *"Power Alarm Disabled"* to indicate that the power alarm is disabled, or
 - The Model 400 will say *"Power Alarm Enabled"* to indicate that the power alarm is enabled.
3. Repeat key sequence to change settings.

5.9 AC Power Failure Recognition Time

The AC Power Failure Recognition Time is the length of time that AC electric power is off before a valid alarm is recognized and dial-out begins. The default setting is 5 minutes, 0 seconds, but is programmable from 0 seconds to a maximum of 540 minutes.

When AC power failure occurs, and throughout the programmed Recognition Time, the Model 400 steadily repeats the message *"the power is off"* at the unit's installation site. There is no Call Delay programming available for AC power failure. Immediately following Recognition Time, the Model 400 begins the dial-out process to report power failure.

To cancel the power-failure message locally at the keypad (during or after Recognition Time) press the ALARM CANCEL key on the Model 400 keypad. This action also cancels the dial-out process.

5.9.1 Programming Power Failure Recognition Time

1. Press SET.



2. Press RECOGNITION TIME.



3. Press POWER. The Model 400 responds: "Enter minutes."



4. Using the number keys, enter the number of minutes. The Model 400 will recite the digits as they are pressed.

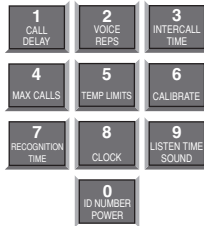

5. Press ENTER. The Model 400 responds: "Enter seconds."



6. Using the number keys, enter the number of seconds. The Model 400 will recite the digits as they are pressed.



7. Press ENTER. The Model 400 responds: "OK."



5.9.2 Interrogating Power Failure Recognition Time

1. Press WHAT IS.



2. Press RECOGNITION TIME.



3. Press POWER.



The Model 400 will recite the power Recognition Time.

5.10 Sound Alarm Monitoring

This feature allows you to program the level and duration of sound that will cause the Model 400 to respond to an alarm and dial-out. It may be useful to desensitize the Model 400 to sound if it is installed in an area with a relatively high noise level, or where a loud noise occurs frequently but is not associated with an alarm. In some applications, it may be desirable to increase sound sensitivity to low sound levels.

5.10.1 Programming Sound Alarm Sensitivity

The sensitivity setting for sound alarm monitoring ranges from 1 to 160. A value of 1 makes the microphone the MOST sensitive to changes in sound. The value 160 makes the microphone the LEAST sensitive to sound. The default value is **32**.

1. Press SET.



2. Press CALIBRATE.



3. Press SOUND. The Model 400 responds: "Enter number."



- Using the number keys, enter a value for sound sensitivity.



The Model 400 recites the digits as you press them.

- Press ENTER. The Model 400 responds: "Okay."



5.10.2 Interrogating Sound Sensitivity

- Press WHAT IS.



- Press CALIBRATE.



- Press SOUND. The Model 400 recites the programmed sound sensitivity level.



5.10.3 Programming High Sound Alarm Recognition Time

The Recognition Time for sound alarm monitoring ranges from 5 seconds to 60 seconds. The default value is 8 seconds.

- Press SET.



- Press RECOGNITION TIME.



3. Press SOUND. The Model 400 responds: "Enter seconds."



4. Using the number keys, enter the number of seconds. The Model 400 will recite the digits as they are pressed.



5. Press ENTER.



5.10.4 Interrogating High Sound Alarm Recognition Time

The Recognition Time for sound alarm monitoring ranges from 5 seconds to 60 seconds. The default value is 8 seconds.

1. Press SET.



2. Press RECOGNITION TIME.



3. Press SOUND. The Model 400 responds: "Enter seconds."



5.11 High Sound Alarm Enable/Disable

The Model 400 monitors sound through the built-in microphone. When the sound level suddenly exceeds the programmed high sound limit, the Model 400 will respond with an alert condition. The increased sound level must continue throughout the programmed recognition time. The default for high sound alarm is enabled (on).

NOTE

The microphone is also used for listening to on-site sounds. Refer to Chapter 4, Section 4.8. Disabling the sound alarm does not affect listen-in capability.

5.11.1 Changing Enabled/Disabled High Sound Alarm

1. Press SENSOR ON/OFF.



2. Press SOUND. The Model 400 will say “*Sound Alarm Disabled*” to indicate disabled or “*Sound Alarm Enabled*” to indicate enabled.



3. Repeat key sequence to change settings.

5.12 Exit Delay

When tripping an alarm is unavoidable, yet a true alert condition has not actually occurred, the alarm response, including dial-out, can be temporarily suppressed.

The Model 400 is able to suppress and then reset its dial-out function automatically through use of the Status Report. This is especially convenient when an alert condition is created upon exiting a monitored door, and there is no way to cancel from the local keypad.

Example: You are planning to exit through a monitored door. Prior to exiting, you initiate a Status Report recitation at the Model 400 keypad by pressing WHAT IS, followed by STATUS, (key sequence shown below). This allows you approximately 40 seconds to exit without activating the Model 400’s programmed response to an alarm. At the conclusion of the status report, normal alarm response is reactivated.

To use exit delay, initiate the Status Report.

1. Press WHAT IS.



2. Press STATUS. The Model 400 recites the full Status Report; during this time, you are able to exit the monitored area without tripping an alarm.



5.13 Designating A Zone As Unused

This feature allows you to mark selected Zones, Power, or Sound as unused, which will prohibit them from going into alarm and will also leave them out of the status report. Note that programming for the selected Zone will be preserved when the Zone is marked as “unused” and will not be reconfigured if automatic Zone configuration is activated.

To designate a Zone as unused:

1. Press the SENSOR ON/OFF key.

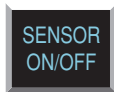

2. Press the SET key.



The 1400 will say “Enter Zone Number.”

3. Press the corresponding number of the Zone you wish to mark as unused.

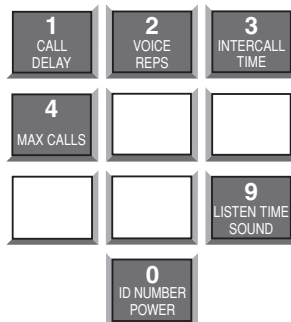

The 1400 will respond by saying Zone 1–4, Power, or Sound “Off/On.” Repeat the key sequence to place the Zone back in use.

Chapter 6: Acknowledgment, Status Report & Remote Access

In addition to communication and alarm monitoring capabilities, the Model 400 will also respond to your instructions and provide you with access to information on monitored conditions at all times.

By issuing commands to the unit, either at the installation site or over standard telephone lines, the following features may be activated:

- Acknowledgment of existing alarms
- The Status Report on all monitored conditions.
- Limited programming.

6.1 Alarm Acknowledgment

When the Model 400 dials out with an alarm message, it will request acknowledgment before hanging up. Acknowledgment indicates to the unit that the alarm message has been received. Upon acknowledgment, the Model 400 will cancel the dial-out sequence.

There are three ways* that an alarm is acknowledged directly:

- Local Acknowledgment
- Touch-Tone™ Acknowledgment
- Callback Acknowledgment

* A fourth method of alarm acknowledgment is indirect. Refer to Max Calls, Chapter 4, Section 4.13 for an example of automatic alarm acknowledgment.

6.1.1 Local Acknowledgment

To acknowledge an alarm locally (directly at the installation site of the Model 400), press the ALARM CANCEL Key.

6.1.2 Touch-Tone™ Acknowledgment

This method of remote alarm acknowledgment works with a Touch-Tone™ telephone.

Example: You receive a call from the Model 400, reporting that an alarm exists. The message concludes: “Enter

Acknowledgement code.” Now, or at any time during this call, you may acknowledge the alarm with the code “555” if you are using a Touch-Tone™ telephone.

- To enter “555,” press the number (5) key on the Touch-Tone™ phone keypad three times. The Model 400 will respond: “**Alarm Acknowledged.**” The Model 400 will hang up and the dial-out sequence, including any further response to the alarm, will be cancelled.
- If you enter the wrong code or do not enter it within 10 seconds following the conclusion of the message, the Model 400 will respond: “**Error, Enter Acknowledgement code.**” If you do not enter the acknowledgement a second time the unit will say “error” then “goodbye” and hang up. The alarm is still not acknowledged until you call back. You have a period equal to the programmed Intercall Time to call the unit back and enter the “555” acknowledgment code. If you are calling from a pulse or rotary telephone, refer to Callback Acknowledgment, Section 6.1.3, below.

6.1.3 Callback Acknowledgment

Callback Acknowledgment is a feature that allows you to acknowledge an alarm without entering Touch-Tones™. This feature is disabled by default and must be enabled by entering the key sequence below. When Callback Acknowledgment is enabled, simply call the unit back and allow the line to ring 10 times. The unit will then answer the call, announce the alarm, then say “Alarm Acknowledged.” This indicates that the alarm has been acknowledged.

To enable or disable Callback Acknowledgment:

1. Press SENSOR ON/OFF.



2. Press STATUS.



The Model 400 will say “*Callback Acknowledgment Enabled*” to indicate that Callback Acknowledgment is Enabled, or “*Callback Acknowledgment Disabled*” to indicate that Callback Acknowledgment is Disabled. This method of remote alarm

acknowledgment works with any telephone: pulse, rotary, or Touch-Tone™.

Example: The Model 400 calls you with an alarm message. You answer the call with a rotary or pulse telephone, and do the following:

- You listen to the message and hang up.
- Then you call the Model 400 back on any telephone. You must wait for 10 rings—this signals the Model 400 to answer your telephone call. (Make sure to call back within the programmed setting for Intercall Time—refer to Chapter 4, Section 4.12.)

When the Model 400 answers your return call, it announces the alarm. Then it says: “*Alarm Acknowledged.*” This indicates that the alarm has been acknowledged.

NOTE

If you have the TAD feature (telephone answering device) enabled, call the unit and let the phone ring once, then hang up. Wait a few seconds then call the unit back a second time. The model 400 will now answer on the first ring. If TAD is disabled, the telephone must be allowed to ring 10 times. This serves as a precaution against a random alarm acknowledgment. Refer to Chapter 4, Section 4.7, for complete information on using the TAD feature.

6.2 Status Report

The Status Report allows access to complete information on all monitored conditions either locally, from the keypad, or by telephone, from any location. The Model 400 will answer an incoming telephone call following the programmed Rings Until Answer (refer to Chapter 4, Section 4.6). Included with the Status Report are messages related to alarm conditions, AC power, battery backup and sound level. It also provides an opportunity for listening to on-site sounds (refer to Listen-in Time, Chapter 4, Section 4.8).

To initiate the Status Report:

1. Press WHAT IS.



2. Press STATUS.



Sections 6.2.1, 6.2.2, and 6.2.3 demonstrate two different Status Report recitations. The Status Report starts with:

"Hello. This is 555-1234 (or the programmed ID), (Custom ID Message)."

"It is now 12:15PM (or the current time)."

The Model 400 proceeds with a separate report for each zone. Each zone identifies itself by reciting the zone number and it's associated voice message.

6.2.1 Example: Status Report, No Alarms

Zones 2, 3, and 4 are configured as dry contact and zone 1 is configured as temperature. No alarms exist. The Status Report begins by saying, *"Hello, this is 555-1234, this is building M, third floor; it is now 2:30 PM."*

Following this introduction, the report continues:

"Zone 1, room temperature, 74 degrees, OK."

"Zone 2, door alarm, OK."

"Zone 3, ups alarm, OK."

"Zone 4, water sensor, OK."

"The sound is OK."

"The power is ON." This refers to AC power.

"The batteries are OK." Other possible responses: *"Batteries are low"* or *"Replace batteries."* (Refer to Section 6.2.4 for additional information regarding battery condition.)

"The output is off."

"Listen to the sound for 10 seconds." In this case, the programmed Listen-in Time is set at 10 seconds. (This feature is not available when obtaining the Status Report on-site, directly at the keypad.)

The Status Report repeats once more and the Model 400 concludes the call, saying: *"Goodbye."* (The Status Report will

not repeat if obtained at the keypad; “Goodbye,” is also not recited.)

The phrase “no number” at the end of a Status Report indicates that no dial-out phone numbers have been programmed.

6.2.2 Example: Status Report, Existing Alarms

Zones 2, 3, and 4 are configured as dry contact and zone 1 is configured as temperature. An emergency situation is at hand: a fire in a greenhouse has tripped a smoke alarm and electrical power has been disrupted. In addition to high sound and AC power alarms, separate alarms exist on zones 1, 2, 3, and 4. You happen to call in for the Status Report, which begins with, *Hello, this is 555-1234; “this is the Sensaphone 400 at ACME Greenhouse, 225 Oak Street”*

It is now 8:45 PM

Zone 1, “Temperature in greenhouse”, 110 degrees Fahrenheit, too high, acknowledged alarm exists

Zone 2, “Door alarm in greenhouse”, not OK, acknowledged alarm exists

Zone 3 “Water pressure alarm in greenhouse”, not OK, acknowledged alarm exists

Zone 4 “Greenhouse control system”, not OK, acknowledged alarm exists

A High Sound alarm exists, it is now too high

The Power is Off.

The Batteries are Low.

The Output is Off.

Listen to the sound for 10 seconds.

Goodbye.

6.2.3 Example: Status Report, Disabled Zones

If a zone is disabled, the dial-out feature for that zone is deactivated, but all other programmed parameters remain in effect. In the example below, all 4 zones are disabled, although zones 1 and 3 are detecting alarms. AC power and Sound Level are also disabled for dial-out. When you call the Model 400 for a Status Report, you hear the following:

Hello, this is 555-1234; "this is the Sensaphone 400 at ACME Greenhouse, 225 Oak Street"

It is now 8:45 PM

Zone 1, "Temperature in greenhouse", the alarm is disabled, it is now 110 degrees Fahrenheit, too high, acknowledged alarm exists

Zone 2, "Door alarm in greenhouse", the alarm is disabled, it is not OK.

Zone 3 "Water pressure alarm in greenhouse", the alarm is disabled, it is not OK.

Zone 4 "Greenhouse control system", the alarm is disabled, it is not OK.

The Sound alarm is disabled, it is now too high

The Power alarm is disabled, it is now Off.

The Batteries are Low.

The Output is On.

Listen to the sound for 10 seconds.

Goodbye.

The Status Report repeats once more and the Model 400 concludes the call, saying: "Goodbye."

6.2.4 Battery Condition

During a Status Report, you may hear one of three possible messages regarding battery power. The Model 400 determines the appropriate message by measuring battery voltage. Depending upon the remaining voltage, it may respond:

- *"The batteries are OK,"* if over 8.2 Volts.
- *"The batteries are low,"* if between 7.2 and 8.2 Volts.
- *"Replace batteries,"* if below 7.2 Volts.

6.2.5 Remote Access by Touch-Tone™ Telephone

You can issue a number of commands to the 400 remotely using a Touch-Tone™ telephone. This command mode can be entered at any time during the status report. Simply press a Touch-Tone™ and the unit will halt the report and respond with "OK." You are

Chapter 6: Acknowledgment, Status Report & Remote Access

now in Touch-Tone™ command mode. Commands are available to perform the following functions:

- Enable and disable zones, power monitoring, and sound monitoring
- Recite/Set High and Low alarm limits
- Recite/Set telephone numbers
- Record/Play custom voice messages
- Recite/Set the relay output
- Activate the microphone for listen-in
- Recite status report

NOTE: If a security code is enabled, the 400 will prompt you with “Enter security code.” Enter the four-digit keypad security code plus “#” to enter touch-tone command mode. If entered correctly, the 400 will respond with “OK” and you can proceed to enter the commands. If entered incorrectly, the unit will give you one more chance. If it is incorrect a second time, the unit will say “Error, goodbye” and hang up.

The commands are put together based on the letters of a touch-tone telephone. See typical telephone keypad layout below.



Many of the commands use three letters that represent an abbreviation of the selected command. For example, to Set a High limit on Zone 1 you would press S + H + 1 (or in numeric form 7 + 4 + 1)

The tables below list all of the touch-tone commands that are supported. Commands are listed in both character and numeric formats. The # key is used as an ENTER key. Use the * key to represent a negative sign or to represent the [CODE] key when programming telephone numbers.

Enable/Disable Zones

This command will toggle the selected zone between the enabled or disabled state.

<u>Description</u>	<u>Touch-Tone Command</u>
Enable/Disable Zone	* + Z(9) + (zone number)

Set and Recite High & Low Alarm Limits

The following commands are used to set or recite the Low Alarm Limit for any Zone.

<u>Description</u>	<u>Touch-Tone Command</u>
Set Zone Low Limit	S(7) + L(5) + (zone #) + (value) + #

<u>Description</u>	<u>Touch-Tone Command</u>
What Is Zone Low Limit	W(9) + L(5) + (zone #)

The following commands are used to set or recite the High Alarm Limit for any Zone.

<u>Description</u>	<u>Touch-Tone Command</u>
Set Zone High Limit	S(7) + H(4) + (zone #) + (value)+ #

<u>Description</u>	<u>Touch-Tone Command</u>
What Is Zone High Limit	W(9) + H(4) + (zone #)

Set and Recite Telephone Numbers

The following commands will allow you to program and recite dialout telephone numbers. You may need to use the Special Dialing Codes below.

Special Dialing Codes Summary

- Code 1: Numeric pager type
- Code 2: Wait for answer
- Code 3: Change to Touch-Tone
- Code 4: Pause
- Code 5: Star (*)
- Code 6: Pound (#)

<u>Description</u>	<u>Touch-Tone Command</u>
Setting a phone number	S(7) + T(8) + (entry 1–4) + (telephone number) + #

<u>Description</u>	<u>Touch-Tone Command</u>
Reciting a phone number	W(9) + T(8) + (entry 1–4)

Record and Play Custom Voice Messages

The following commands will allow you to record and play back custom voice messages for the ID message (0) and each zone (1–4).

<u>Description</u>	<u>Touch-Tone Command</u>
Record a Message	S(7) + M(6) + (entry 0–4)

<u>Description</u>	<u>Touch-Tone Command</u>
Play a Message	W(9) + M(6) + (entry 0–4)

Control the Relay Output

The following commands will allow you to check the status of the relay output and to toggle the Relay Output On and Off.

<u>Description</u>	<u>Touch-Tone Command</u>
Reciting the Output Status	W(9) + R(7) + O(6)

<u>Description</u>	<u>Touch-Tone Command</u>
Switching the Output	S(7) + R(7) + O(6)

Activate Microphone Listen-in

The following command will allow you to activate the microphone listen-in for the programmed duration.

<u>Description</u>	<u>Touch-Tone Command</u>
Activate Mic Listen-in	M(6) + I(4) + C(2)

Request Status Report

The following command will initiate a status report.

<u>Description</u>	<u>Touch-Tone Command</u>
Recite status report	W(9) + S(7) + R(7)

Hang-up

The following command will make the 400 hang up the telephone line.

<u>Description</u>	<u>Touch-Tone Command</u>
Hang-up the phone line	B(2) + Y(9) + E(3)

Chapter 7: Operation

After installation and programming is completed, the Model 400 is fully operational. This chapter explains the sequence of events that occur during an alarm dialout to illustrate how the Model 400 operates.

7.1 Alarm Detection, Dial-out and Acknowledgment

Generally, an alarm event is structured in the following manner:

- I. The Model 400 detects an alert condition due to a change at the sensor.
- II. A valid alarm is recognized.
- III. Dial-out begins.
- IV. The alarm is acknowledged.

Often, an alarm does not proceed through all stages: either an alert condition does not persist long enough to be considered valid, or a valid alarm is cancelled.

The table on the following pages explains the alarm detection, dial-out and acknowledgment features and lists important variable factors affecting their operation.

I. Model 400 Detects a Change at the Sensor	Variable Factors
<ul style="list-style-type: none"> • Model 400 detects a change in the monitored condition (from the sensor wired to one of the zones). This is considered an alert condition, and does not qualify as a valid alarm at this point. • The condition continues throughout the programmed Recognition Time. If the condition (or sensor) reverts to its normal state before the Recognition Time is reached, no alarm will occur. 	<p><i>Zone Type: (1) An open circuit closes, (2) a closed circuit opens, or (3) temperature limits are exceeded.</i></p> <p><i>Recognition Time: Activated</i></p>
II. A Valid Alarm Is Recognized	Variable Factors
<ul style="list-style-type: none"> • The condition must persist long enough to meet or exceed the programmed Recognition Time. When Recognition Time has expired, but the alert condition continues, the Model 400 will determine that a valid alarm exists. • When a valid alarm is determined, Call Delay is activated, forcing the Model 400 to wait for a programmed period of time before starting the dial-out process. Call Delay applies to the period just prior to dial-out, before the first telephone call is made. • Call Delay provides the opportunity to cancel a valid alarm at the Model 400's installation site, before dial-out occurs. An audible voice message indicates which of the zones is in alarm. If on-site personnel acknowledge the alarm within the Call Delay time, the Model 400 will not dial out. (Local Voice Mute is disabled, so that alarm messages can be heard at the site.) 	<p><i>Recognition Time: Expired</i></p> <p><i>Valid Alarm: Exists</i></p> <p><i>Call Delay: Activated</i></p> <p><i>Alarm Message: Audible, On-site Activated</i></p> <p><i>Local Voice Mute: Disabled</i></p>

III. Dial-out Begins	Variable Factors
<ul style="list-style-type: none"> • The dial-out process is activated as soon as the Call Delay time expires (if the alarm has not been cancelled at the Model 400's installation site.) The dial-out begins with telephone number 1 and proceeds sequentially, through the remaining telephone numbers. • If the alarm is not acknowledged with the first dial-out telephone call, the Model 400 waits the duration of Intercall Time before dialing the next telephone number. Intercall Time is the programmed waiting period in between each dial-out telephone call. • When the telephone is answered, the programmed Voice Repetitions determine the number of times per call the Model 400 recites the alarm message. • Call Progress, an automatic feature, enables the Model 400 to detect whether or not the telephone call is answered. After 10 rings, or if a busy signal is encountered, the Model 400 will hang up, wait the programmed Intercall Time, and proceed to dial the next telephone number. • If no telephone calls are answered, the Model 400 dials out sequentially, through the remaining telephone numbers and continues to cycle until the programmed Maximum Number of Calls is reached. • When the telephone is answered, the Model 400 will immediately begin reciting a message that indicates which of the zones is in alarm. At the same time, the alarm message is repeating at the Model 400's installation site. The Model 400 will request acknowledgment, if it has not yet occurred. 	<p><i>Call Delay:</i> <i>Expired</i></p> <p><i>Intercall Time:</i> <i>Activated</i></p> <p><i>Voice Repetitions:</i> <i>Activated</i></p> <p><i>Call Progress:</i> <i>Activated</i></p> <p><i>Max Calls:</i> <i>Activated</i></p> <p><i>Alarm Messages:</i> <i>By Telephone</i> <i>and</i> <i>On site</i></p>

IV. The Alarm Is Acknowledged	Variable Factors
<ul style="list-style-type: none"> • At any time after a valid alarm is determined, the alarm may be acknowledged at the Model 400's installation site, by pressing ALARM CANCEL key. • When the Model 400 dials out and the call is answered via Touch-Tone telephone, any alarm may be instantly acknowledged by pressing "555." • If the alarm message repeats for the number of programmed Voice Repetitions, and "555" has not been entered, the Model 400 will say: <p><i>"Enter acknowledgement code."</i></p> <p>The Model 400 waits 10 seconds for the Touch-Tone code "555" to be entered. If the code is entered within 10 seconds, it responds: <i>"Alarm acknowledged."</i></p> <p>The alarm is considered acknowledged and the dialout concludes.</p> • If the Model 400 does not receive the Touch-Tone code within 10 seconds, it recites the following: <p><i>"Error, enter acknowledgement code."</i></p> <p>If the Model 400 does not receive the acknowledgement code a second time, it says "error, goodbye" and hangs up. The recipient of this message must call the Model 400 back within the period programmed for Intercall Time, in order to acknowledge the alarm. If Local Voice Mute is off, the unit will beep at the installation site while waiting for this call.</p> • Callback Acknowledgement: If enabled, the Model 400 waits 10 rings before 	<p><i>Local, On-site Acknowledgment</i></p> <p><i>Touch-Tone Acknowledgment: Fast Code 555</i></p> <p><i>Touch-Tone Acknowledgment: Normal Code 555</i></p> <p><i>Tone or Pulse Callback Acknowledgment: Within Intercall Time</i></p>

IV. The Alarm Is Acknowledged	Variable Factors
<p>answering to guard against random acknowledgment. If an answering device is connected to the same line as the Model 400 (and TAD is enabled), you must call the unit and let the line ring once, then hang up, wait ten seconds and call back again within 30 seconds. The Model 400 will answer on the first ring. It will recite any unacknowledged alarms, then say:</p> <p><i>“Alarm acknowledged, goodbye.”</i></p> <p>When the Model 400 hangs up, the alarm is acknowledged and dial-out stops.</p> <ul style="list-style-type: none"> • If calls remain unanswered, or if they are received by an answering machine or FAX, the Model 400 continues the dialout sequence; it waits the Intercall Time and proceeds to dial the next telephone number. Telephone numbers are dialed sequentially, and this cycle continues for the number of Max Calls programmed. If no acknowledgment occurs, then at the completion of Max Calls, the alarm is automatically acknowledged and the dial-out process is terminated. 	<p><i>Tone or Pulse Callback Acknowledgment: TAD Enabled</i></p> <p><i>Max Calls Acknowledgment</i></p>

NOTE

Acknowledging the alarm does not correct the situation! The alarm condition will still exist until the sensor is restored to its normal state.

7.2 Example: A Dial-out Telephone Call

The following parameters are selected for demonstration purposes:

- Model 400 Unit ID Number is set to 555-5674.
It is currently installed at your place of business.
- Dial-out Telephone Number 1 is programmed to 555-1234, your home telephone number.
- Voice Repetitions are set to 4.

The Model 400 is detecting an alarm on zone 2.

The telephone rings at 555-1234, your home number.

You answer the telephone and hear the following message:

“Hello, this is 555-5674. This is the Sensaphone 400 at John’s Printing Express. It is now 12:30 AM. Zone two, back door security sensor, alarm exists, it is not okay.”

(4-seconds to hear on-site sound from unit’s microphone.)

“Hello, this is 555-5674. This is the Sensaphone 400 at John’s Printing Express. It is now 12:30 AM. Zone two, back door security sensor, alarm exists, it is not okay.”

(4-seconds to hear on-site sound from unit’s microphone.)

“Hello, this is 555-5674. This is the Sensaphone 400 at John’s Printing Express. It is now 12:30 AM. Zone two, back door security sensor, alarm exists, it is not okay.”

(4-seconds to hear on-site sound from unit’s microphone.)

“Hello, this is 555-5674. This is the Sensaphone 400 at John’s Printing Express. It is now 12:30 AM. Zone two, back door security sensor, alarm exists, it is not okay.”

(4-seconds to hear on-site sound from unit’s microphone.)

“Enter acknowledgement code.”

NOTE

It is important that your dial-out telephone numbers be answered by you or other authorized personnel in order to ensure adequate response to an alarm.

Chapter 8: Controlling the Output

The Sensaphone 400 includes a relay output that can be used to control a light, siren, or other device. The output is a Form-C Normally Open/Normally Closed mechanical relay and is rated for up to 30VAC/VDC 1A. A sample wiring diagram is shown below:

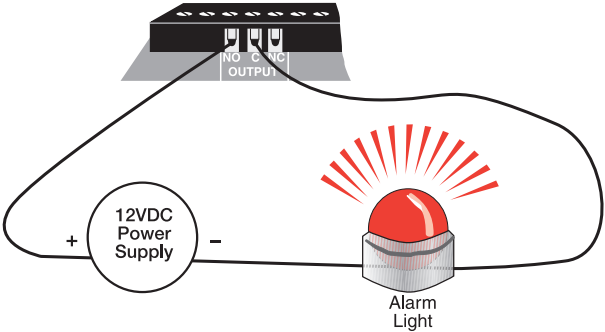

Figure 1: Relay output connected to alarm

The output can be programmed to operate in one of 9 automatic modes or it can operate in manual mode (default). The 9 *automatic* modes allow the output to automatically turn on and off based on individual alarms or any alarm. In *manual* mode the output is controlled via keypad command or remotely via touch-tone phone. A description of each mode is described below.

8.1 Output Modes

Mode	Description
1	Output on when zone 1 goes into alarm. Off when alarm is acknowledged.
2	Output on when zone 2 goes into alarm. Off when alarm is acknowledged.
3	Output on when zone 3 goes into alarm. Off when alarm is acknowledged.
4	Output on when zone 4 goes into alarm. Off when alarm is acknowledged.

Mode	Description
9	Output on when a Sound alarm occurs. Off when alarm is acknowledged.
0	Output on when a Power alarm occurs. Off when alarm is acknowledged.
Phone	Output on when phone line is unplugged for more than 15 seconds. Off when a phone line is plugged in.
*	Output on when any alarm occurs. Off when all alarms are acknowledged.
#	Output controlled manually via keypad command or touch-tone telephone. (default)

8.1.1 To program the Output Mode:

1. Press the SET key.



2. Press the OUTPUT key.



The 400 will say “Enter output mode.”

3. Using the number keys, enter a value for the output mode.

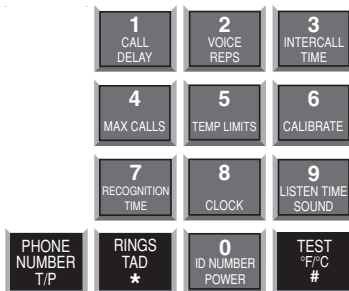

4. Press the ENTER key.

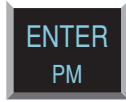

The 400 will say “OK” and recite a description of the mode selected, such as “Automatic on Zone 1” or “Manual.” Note that when *Mode ** is selected, the 400 will simply say “Automatic on Alarm,” meaning that the output will automatically turn on when any alarm occurs.

8.1.2 To play back the programmed Output Mode:

1. Press WHAT IS.

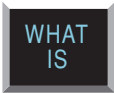

2. Press OUTPUT.



The 400 will recite the programmed output mode.

8.2 Switching The Output Using The Keypad

When programmed for Manual mode, the command to switch the output is:

SENSOR ON/OFF + OUTPUT.

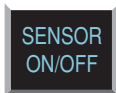

The 400 will respond “The output is on/off” to indicate the state of the output.

Note: If the 400 says “Error,” the output is not programmed for manual mode.

8.2.1 Switching the Output Over the Phone

The following commands will allow you to check the status of the relay output and to toggle the Relay Output On and Off.

To recite the Output Status press W(9) + R(7) + O(6)



To switch the Output press S(7) + R(7) + O(6)



8.3 Typical Applications

Heating Up Your Cottage Or Cabin Remotely

If you keep your cottage or cabin open all year around, or if you do not drain your pipes and add antifreeze to your plumbing, you likely keep your furnace active when you are away but at a very low temperature. The Sensaphone will provide an invaluable service to you by keeping you updated to any change in the status of your furnace operation. Prior to your arrival at your cottage or cabin, you can remotely use your Sensaphone 400 to raise the thermostat and increase the heat.

Most furnaces use a typical 4-wire (heat/cooling) or 3-wire (heat only) thermostat. The Sensaphone can easily control these types of thermostats. *If your heating source consists of high voltage electric baseboard heaters, you should consult a qualified electrician or heating professional for proper installation of the Sensaphone remote control facility.* Electric baseboard heaters may utilize either a low voltage (2-wire) thermostat or a direct control high voltage thermostat. Only the low voltage thermostat may be directly connected to the Sensaphone.

8.3.1 Single Thermostat Control

There are two installation methods that can be used to remotely change the thermostat setting in your cottage or cabin; the single thermostat method and the dual thermostat method (see section 8.3.2 for details on the dual thermostat method). The single thermostat method requires you to install a model with an input to switch between two temperature settings. Sensaphone

offers a 7-day programmable thermostat and power supply which has this feature (order part #'s FGD-0064 & XFR-0024). This thermostat has been carefully chosen to work with the model 400 to allow remote control between normal or vacation mode. You will need to replace your current thermostat, so if you are unsure about performing this work yourself, please contact a licensed heating/cooling professional for installation assistance. Follow the manufacturer's instructions for installing the thermostat.

The Model 400 will need to be wired to the thermostat to control it. For a visually appealing installation you may want to locate the Sensaphone close to your heater so that the cable follows the same path as the one from your heater to the thermostat. An added benefit of this location is that you can easily add a water sensor to monitor for leaks around your hot water heater or other plumbing. Typically the water heater is located near the heating and cooling system.

Step 1: Install the thermostat.

Refer to the manufacturer's instructions for installation. For installation assistance, contact Aube Technologies at 1-800-831-AUBE.

Step 2: Mount the Sensaphone 400.

Choose a location for your Sensaphone that allows for easy wiring to the thermostat, such as near your heater/air conditioning system. Mount the unit on a wall or flat on a desktop or table surface. Plug in the power supply and connect the telephone line.

Step 3: Connect cable from thermostat to Sensaphone 400.

This Sensaphone 400 has a terminal strip below the input/output wiring door that will connect to the 12VDC power supply and X & C terminals of the thermostat (See Figure 1). This connection is required to switch the thermostat between normal and vacation modes. Run a two-conductor cable from the thermostat to the Model 400. On the thermostat, connect the red wire to the X (+) terminal, and the black wire to the C (-) terminal. On the 400, connect the red wire to the NO terminal. Connect the black wire to the negative wire from the power supply. Use a wire nut to complete this connection. Connect the positive wire from the power supply to the "C" terminal on the model 400.

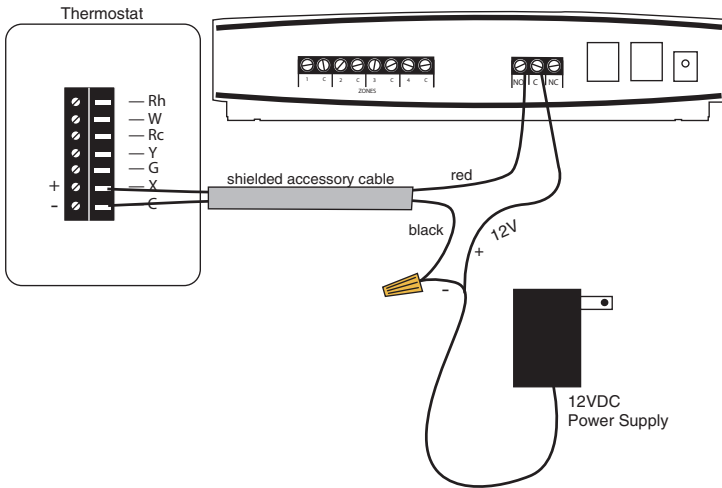

Step 4: Program the Thermostat.



Refer to the manufacturers instructions for programming the thermostat. Be sure to program settings for both normal and vacation modes.

Controlling the Thermostat

The operating mode of the thermostat (*normal/vacation*) can be controlled at the Model 400 keypad or remotely via Touch-Tone comands. Both methods are described below:

Keypad commands:



1) To enable *Vacation Mode*, press the [SENSOR ON/OFF] key, then the [OUTPUT] key. The unit will respond by saying “ON” to indicate that *Vacation Mode* is set. The *Suitcase* icon  will appear and blink on the thermostat LCD.

2) To enable *Normal Mode*, press the [SENSOR ON/OFF] key, then the [OUTPUT] key. The unit will respond by saying “OFF” to indicate that *Normal Mode* is set. The *Sun*  or *Moon*  icon will appear on the thermostat LCD.

TouchTone Commands:

Call the Sensaphone. When the unit answers, it will begin reciting a status report. At any time during the call, press a Touch-Tone. The unit will respond with “OK.” The Sensaphone is now ready to accept Touch-Tone commands.

1) To enable Vacation Mode, press SRO (776). The unit will respond by saying “ON” to indicate that Vacation Mode is set. The *Suitcase* icon  will appear and blink on the thermostat LCD.

2) To enable Normal Mode, press SRO (776). The unit will respond by saying “OFF” to indicate that Normal Mode is set. The *Sun*  or *Moon*  icon will appear on the thermostat LCD.

3) To check the status of the output press WRO (976). The unit will respond “OFF” for Normal Mode or “ON” for Vacation Mode.

4) Hang up.

8.3.2 Dual Thermostat Control

When a three or four wire low voltage thermostat is used, it is easy to connect the Sensaphone to your furnace with the addition of a secondary thermostat. One thermostat is set to your preferred “away” temperature and the other thermostat is set to your preferred “home” temperature. With your Sensaphone 400, you will be able to switch between these two thermostats using the relay output.

Ideally, the “away” thermostat would be in your pump or furnace room. Remember that your “away” thermostat will be the only thermostat that keeps your cottage or cabin at minimal heat while you are away. It should not be located near a window or where direct sunlight might warm it, near a furnace radiator or vent, or any heat source such as a pilot light.

The second thermostat, the one pre-set for your preferred temperature when you arrive at your cottage or cabin, should be located in your normal living space. This would likely be your existing thermostat, already located in a suitable location by your heating professional at the time your furnace was installed.

By connecting these two thermostats together in a parallel fashion, and by passing the low voltage supply through the Sensaphone (See Figure 1), you can remotely or locally decide which thermostat is in control of your furnace.

It is recommended that the “away” thermostat be connected to the NC (Normally Closed) terminal while the “home” thermostat be connected to the NO (Normally Open) terminal of the Sensaphone. This way, it's easy to understand which state your furnace is in: *Output ON = Home* and *Output OFF = Away*. The supply voltage from your furnace (typically the wire labeled R or 24VAC), should always be connected to the C (Common) terminal on the 400.

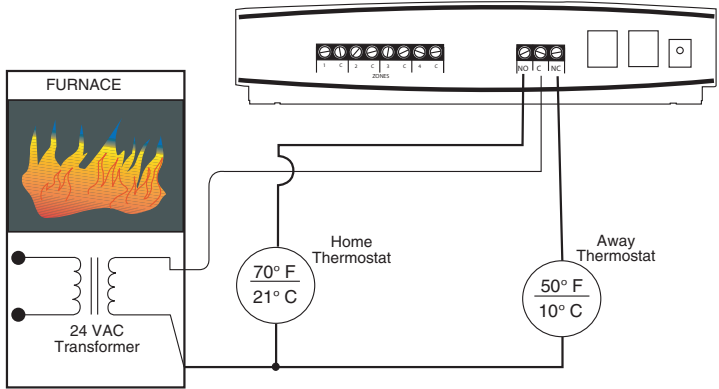

Figure 1: Dual Thermostat Setup

Note: This is a typical configuration when using standard single-zone heat/cool thermostats. For ease-of-use it is recommended that both thermostats be the same model. Note also that all thermostats may not be compatible with the dual-thermostat wiring diagram. Consult your heating/cooling professional for installation assistance.

8.3.3 Controlling Lights Or Other Devices

Using X10 technology, you can remotely activate any electrical device or appliance in your home through your Sensaphone. X10 technology is a suite of control modules that plug into your existing electrical outlets and transmit coded signals to lamps, lights, and appliances to turn them on or off (See Figure 2).

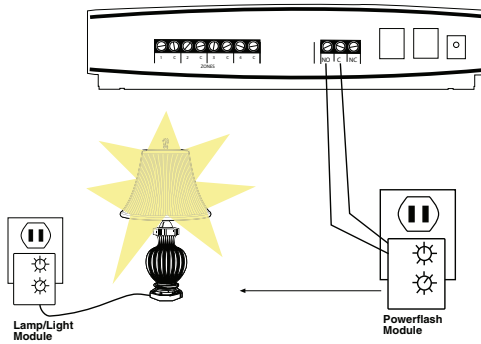

Figure 2: X10 Lighting Control Setup

Sensaphone supports these devices through use of the popular X10 Powerflash relay interface. To learn more about this technology, consult X10 products on the web at www.x10.com or visit your local electronics shop such as Radio Shack.

Such applications may include turning on a lamp or exterior lights remotely from your cellular telephone when arriving at your residence late at night. Or you can use the X10 Powerflash Module (set to momentary contact) in conjunction with the X10 Universal Module to remotely control your electric garage door opener over the telephone—an ideal way of letting in your service personnel without being on-site. You may also use the X10 technology to send the ON/OFF signal to a furnace or heater if your thermostat is not easy to wire directly.

Finally, in addition to remotely controlling devices, X10 technology lets you extend the reach of certain Sensaphone sensors such as door contacts, motion sensors, or water sensors. This is of great benefit where it is impossible to wire directly from your sensors to your Sensaphone. Consult a qualified electrician or your heating professional for assistance with locating your remote sensors or contact your Sensaphone dealer.

Appendix A: Weekly Testing Procedure

We recommend that you test your Sensaphone weekly to be sure it is functioning properly. This will ensure that when a problem arises the Sensaphone will be ready to alert the appropriate personnel.

There are several tests that can be performed:

- 1) Call the unit and listen to the Status Report. This will test the unit's ability to answer the phone and speak a message. It will also verify that all of the zones are reading properly, the alarm conditions are OK, the electricity is on, the microphone is functioning, and the batteries are OK.

- 2) Create an alarm on each zone by tripping all connected sensors.

Temperature sensors: Heat or cool the sensor.

Motion sensors: Have someone walk in front of the sensor.

Door/window sensors: open the door/window.

Water sensors: Apply a small amount of water beneath the sensor or use a wet towel and touch it to the sensor probes.

Humidity sensors: Raise the humidity around the sensor by holding a cup of very hot water beneath the sensor.

Allow the unit to contact all programmed telephone numbers. This will make sure that the Sensaphone is programmed properly. It will also prepare personnel to respond appropriately when they receive a call from the Sensaphone.

- 3) Test the batteries by unplugging the AC adapter and making sure that the Sensaphone continues to function. Press WHAT IS, then STATUS on the keypad, and listen to the status report. Make sure the report states that *"the power is off"* and *"batteries are OK."* Keep the AC adapter unplugged so that a Power Failure alarm occurs. Allow the unit to dial all programmed telephone numbers while running on battery backup. Plug in the AC adapter after the unit has finished dialing all of the telephone numbers.

Sensaphone® Model 400 User's Manual

- 4) If you are using your Sensaphone to listen for a smoke alarm, then be sure to test the smoke alarm to make sure that the Sensaphone picks up the audible signal and triggers a high-sound-level alarm. Allow the unit to dial all programmed telephone numbers.
- 5) Keep a log of your tests, noting the date and whether the 400 passed in each category tested. An example of such a log is shown below. (See "Test Log" at the end of this manual.)

400 Test Log							
Date	Inputs		Dialout		Call-in		Tested by
7/1/04	Pass <input checked="" type="checkbox"/>	Fail <input type="checkbox"/>	Pass <input checked="" type="checkbox"/>	Fail <input type="checkbox"/>	Pass <input checked="" type="checkbox"/>	Fail <input type="checkbox"/>	Bob H
7/15/04	Pass <input checked="" type="checkbox"/>	Fail <input type="checkbox"/>	Pass <input checked="" type="checkbox"/>	Fail <input type="checkbox"/>	Pass <input checked="" type="checkbox"/>	Fail <input type="checkbox"/>	Alex G.
7/22/04	Pass <input checked="" type="checkbox"/>	Fail <input type="checkbox"/>	Pass <input checked="" type="checkbox"/>	Fail <input type="checkbox"/>	Pass <input checked="" type="checkbox"/>	Fail <input type="checkbox"/>	Bob H.
	Pass <input type="checkbox"/>	Fail <input type="checkbox"/>	Pass <input type="checkbox"/>	Fail <input type="checkbox"/>	Pass <input type="checkbox"/>	Fail <input type="checkbox"/>	
	Pass <input type="checkbox"/>	Fail <input type="checkbox"/>	Pass <input type="checkbox"/>	Fail <input type="checkbox"/>	Pass <input type="checkbox"/>	Fail <input type="checkbox"/>	

Appendix B: Troubleshooting

In the event that a problem is encountered, this section will assist you in determining the cause, so you can return the unit to its usual monitoring routine with minimal interruption.

Most problems with the Model 400 are easy to identify and quickly corrected, and are found under the following general headings:

- Error Messages
- Communications/dial-out functions
- Temperature monitoring
- Sound level monitoring
- Other monitoring functions

Error Messages

Problem	Cause	Solution
1. The unit says "Error 1."	An invalid value has been entered or too much time has passed without entering a value.	Only enter values within the allowed programming range, and make programming changes in a timely fashion.
2. The unit says "Error 2."	Programming changes were attempted without unlocking the keypad.	Unlock the keypad, then make programming changes.

Communications / Dial-out:

Problem	Cause	Solution
1. The Model 400 fails to dial out.	<ul style="list-style-type: none"> a) The telephone number may be incorrectly programmed. b) Tone or pulse (the current dialing method) is not compatible with the telephone line on which the Model 400 is installed. c) Recognition Time is too long. An alert condition does not remain in effect long enough to become a valid alarm. 	<p>Recheck programming steps. Refer to Chapter 4, Section 4.2.1.</p> <p>Switch from the current setting: from tone to pulse, or from pulse to tone. Refer to Chapter 4, Section 4.3.</p> <p>Reprogram Recognition Time. Set the Recognition Time to the minimum duration required to create a valid alarm. If possible, test the new setting by deliberately creating an alert condition. Refer to Chapter 5, Section 5.3.</p>

Communications / Dial-out:

Problem	Cause	Solution
<p>2. The Model 400 will not answer the telephone when called for a Status Report or alarm acknowledgment.</p>	<p>e) The Model 400 is connected to an incompatible telephone line.</p> <p>a) Rings Until Answer is incorrectly programmed.</p> <p>b) The Model 400 is connected to an incompatible telephone line.</p>	<p>The Model 400 must be connected to a standard (2-wire analog) telephone line, not a digital extension to a phone system. If the unit will not dial out and the factors previously listed have been ruled out, try connecting the unit to a standard residential telephone line.</p> <p>Recheck programming of Rings Until Answer. Refer to Chapter 4, Section 4.5.1.</p> <p>Some telephone systems will not allow the telephone to ring beyond 4 rings. If your Model 400's Rings Until Answer is set at more than 4 rings, you may not be able to access the unit. Try setting the Rings Until Answer to less than 4 rings. If this does not correct the problem, it may indicate telephone line incompatibility. In this case, try connecting the Model 400 to a standard, residential telephone line.</p>

<p>3. The Model 400 will not answer the telephone for Callback Acknowledgement.</p>	<p>You did not allow the telephone to ring 10 times. Note: If the TAD (telephone answering device) is disabled, the telephone rings ten times before the Model 400 answers. If the TAD is enabled, you must call the unit and let the line ring once, then hang up, wait ten seconds and call back again within 30 seconds.</p>	<p>When calling the Model 400, and the TAD is disabled, allow the telephone to ring 10 times. Refer to Chapter 6, Section 6.1.3, and Chapter 4, Section 4.6.3.</p>
<p>4. The Model 400 recites the alarm message or Status Report over the telephone, but is silent at the installation site.</p>	<p>The local voice mute feature is in effect.</p>	<p>Deactivate local voice mute. Refer to the programming steps in Chapter 4, Section 4.9.</p>
<p>5. The Model 400 and telephone answering device (sharing the same line) answer incoming calls simultaneously.</p>	<p>The Model 400's number of Rings Until Answer is set to equal the number of rings set for the telephone answering device.</p>	<p>Change the number of Rings Until Answer for the Model 400. Refer to Chapter 4, Section 4.5.</p>

Temperature Monitoring:

Problem	Cause	Solution
1. Can't program temperature limits; or the unit won't read the temperature sensor.	The zone isn't configured to read a temperature sensor.	Press SET and CONFIGURE to program the zone. (See Section 5.1.1 for more information on configuring zones.)
2. The temperature reading is -20° F or -30° C.	The temperature sensor has been disconnected or has broken wires.	Examine the wires to temperature sensor and connect or replace wiring.
3. Temperature reads 150° F or 65° C.	Temperature sensor wires are touching or have shorted.	Verify and correct wiring.
4. Temperature reading is inaccurate.	<p>a) Temperature sensing may be affected by a source of ambient heat (ie., direct sunlight, or heat duct proximity).</p> <p>b) Temperature may require calibration.</p> <p>c) The unit is using the wrong temperature scale (Fahrenheit vs. Celsius).</p>	<p>Try moving the unit to a different location.</p> <p>After moving or placing the unit away from ambient heat sources, the temperature may be calibrated to offset inaccurate normal reading by several degrees. Refer to Chapter 5, Section 5.6.</p> <p>Verify temperature scale. Refer to Chapter 5, Section 5.5.</p>

<p>5. False high temperature alarms from freezer.</p>	<p>Most freezers have a defrost cycle during which the temperature will rise considerably, thus causing an alarm to occur.</p>
<p>6. The Sensaphone calls with a high/low temperature alarm but recites a temperature that's within the programmed limits.</p>	<p>The Sensaphone recites the "current" temperature when it calls you, not the temperature at the time the alarm occurred. It is likely that the temperature has changed since the time the alarm was detected and has since returned to normal operating conditions.</p>

Sound Level Monitoring:

Problem	Cause	Solution
<p>1. False high sound alarms occur frequently.</p>	<p>The programmed sound sensitivity results in over-sensitivity to non-alarm sound as well as alarm sound. Sound Recognition Time is too short.</p>	<p>Reprogram the sound sensitivity. Refer to Chapter 5, Section 5.10. Lengthen the sound Recognition Time. Refer to Chapter 5, Section 5.10.</p>
<p>2. High sound does not cause an alarm.</p>	<p>The unit is not close enough to the high sound source, or the programmed sound setting results in a lack of sensitivity to high sound.</p>	<p>Move the unit closer or reprogram the sound sensitivity. Refer to Chapter 5, Section 5.10.</p>

Other Monitoring:

Problem	Cause	Solution
<p>1. Alarm status of an alert zone is incorrect.</p>	<p>Incorrect zone normality.</p>	<p>Reconfigure the zone. Refer to Chapter 5, Section 5.1.</p>
<p>2. False power out alarms</p>	<p>Programmed Recognition Time is too short.</p>	<p>AC power is often subject to brief interruptions. To avoid frequent, false alarms, increase the power Recognition Time. Refer to Chapter 5, Section 5.9.</p>
<p>3. The Model 400 does not recognize power failure.</p>	<p>a) Batteries are either incorrectly installed or drained.</p> <p>b) Recognition time setting is too long.</p>	<p>To verify proper battery function, unplug the unit and verify continued operation using batteries only. If unit ceases to function, first try reinstalling the batteries. If this is not successful, replace the batteries. Refer to Chapter 2, Section 2.4 for complete instructions.</p> <p>Reprogram Recognition Time. Set the Recognition Time to the minimum required before a valid alarm occurs. If possible, test the condition by deliberately creating an alert condition. Refer to Chapter 5, Section 5.9.</p>

<p>4. The Model 400 does not recognize any alarm.</p>	<p>a) Zones for alarm are disabled. Enable the zones for alarm. Refer to Chapter 5, Section 5.2.</p> <p>b) Programmed Recognition Time is too long. Reprogram Recognition Time. Set the Recognition Time to the minimum required for a monitored condition to become a valid alarm. If possible, test the condition by deliberately creating an alert condition. Refer to Chapter 5, Section 5.3.</p>
<p>5. The batteries drain prematurely.</p>	<p>The unit's AC transformer is unplugged or for some other reason, full AC power is not available to the unit. The batteries will take over powering the unit when the AC transformer is unplugged from the 120 VAC outlet. When storing the unit, be sure to remove the batteries. Refer to Chapter 2, Section 2.4. <i>Be sure to use alkaline batteries—do not use rechargeable batteries.</i></p>

If the solutions offered above do not appear to correct the problem, apply the following steps, in the order shown.

- Remove the batteries.
- Unplug the unit.
- Wait one minute for the Model 400 to completely power down.
- Plug in the unit's AC adaptor into a standard 120 VAC outlet.
- Replace the batteries.

Refer to Chapter 2, Installation, for additional information on batteries and installation procedures.

Appendix C: 400 QUICK REFERENCE

Parameter	Description	Key Sequence*	Range	Default
Call Delay	Time delay until first call is made	[SET] or [WHAT IS] + [CALL DELAY]	Min: 00:00 Max 60:00 (min:sec)	00:30 (min:sec)
Voice Repts	Number of times alarm message is repeated over the phone	[SET] or [WHAT IS] + [VOICE REPS]	Min: 1 rep Max: 10 reps	3 reps
Intercall Time	Time delay between phone calls	[SET] or [WHAT IS] + [INTERCALL TIME]	Min: 00:10 Max: 60:00 (min:sec)	01:00 (min:sec)
Max Calls	Number of calls until unit self-acknowledges	[SET] or [WHAT IS] + [MAX CALLS]	Min: 1 call Max: 255 calls	100 calls
Temp Limits	High and low temperature alarm limits	[SET] or [WHAT IS] + [TEMP LIMITS] + [zone #]	Min: -20°F/-30°C Max: 150°F/65°C	Low: 10°F High:100°F
Calibrate	Temperature Correction factor	[SET] or [WHAT IS] + [CALIBRATE] + [zone #]	Min: -10° Max: 10°	0°
Recognition Time: zones 1-4	Length of time a fault condition must exist to trip an alarm	[SET] or [WHAT IS]+ [RECOGNITION TIME]	Min: 00:00 Max: 540:00 (min:sec)	00:03 (min:sec)
Recognition Time: Power Failure	Length of time the power must be off to trip an alarm	[SET] or [WHAT IS] +[RECOGNITION TIME]+[POWER]	Min: 0:00 Max: 540:00 (min:sec)	05:00 (min:sec)
Recognition Time: High Sound Level	Length of time the sound must be high to trip an alarm	[SET] or [WHAT IS] +[RECOGNITION TIME]	Min: 5 Max: 60 (sec)	00:08 (min:sec)
Clock	Real time clock	[SET] or [WHAT IS] + [CLOCK] + [time] + [AM] or [PM]		12:00 AM
High Sound Level Alarm Sensitivity	Microphone sensitivity for high sound level alarm	[SET] or [WHAT IS] + [CALIBRATE] + [SOUND]	Min: 1 unit Max: 160 units	32 units
Listen Time	Length of listen-in time during call-in status report	[SET] or [WHAT IS] + [LISTEN TIME]	Min: 0 sec Max: 255 sec	15 sec
Rings Until Answer	Number of rings until unit answers an incoming call	[SET] or [WHAT IS] + [RING]	Min: 1 ring Max: 15 rings	4 rings

* press [ENTER] after all Key Sequences starting with [SET]

Sensaphone® Model 400 User's Manual

Parameter	Description	Key Sequence*	Range/ Response	Default
TAD	Telephone Answering Device Compatibility	[SENSOR ON/OFF] + [TAD]	Enable / Disable	Disabled
ID Number	Sets the unit's telephone number	[SET] + [ID NUMBER]	0-16	
Dialout Test	Permits testing of dialout Telephone numbers	[SET] + [TEST]+ [1-8]	1-8	
Output Mode	Sets the relay output Mode	[SET] + [OUTPUT]	1-4, *, #, PHONE	Manual
Output Control	Switches the relay output On or Off (manual mode)	[SENSOR ON/OFF] + [OUTPUT]		Off
Voice Message	Program or recite voice messages	[SET] or [WHAT IS] + [MESSAGE]+[RE COGNITION TIME] + [zone#]	0-4	
Zone Configuration	Program or recite zone configuration	[SET] or [WHAT IS] +[CONFIG]	temp, NO, NC	No
Call Progress	Turns call progress Detection on or off	[SENSOR ON/OFF] + [CONFIG]	Enable / Disable	Enabled
Telephone Number	Program or recite dialout telephone numbers	[SET] + [PHONE NUMBER] + [1-8]		
Status Report	Recites a Status Report	[WHAT IS] + [STATUS]		
Run/Standby Mode	Changes the operating mode between run and standby	[RUN/STANDBY]		Run

Appendix C: Quick Reference

Parameter	Description	Key Sequence	Response	Default
Speaker Mute	Turns off the speaker during alarm conditions	[SENSOR ON/OFF] + [MUTE]	On or Off	off
Designating A Zone Unused	Removes zone from status and alarm reports	[SENSOR ON/OFF] + [SET] + [zone #]	On or Off	On
Zone Enable/Disable	Turns zone alarm detection on or off	[SENSOR ON/OFF] + [zone#]	Enabled / Disabled	Enabled
Power Alarm Enable/Disable	Turns power alarm detection on or off	[SENSOR ON/OFF] + [POWER]	Enabled / Disabled	Enabled
Sound Alarm Enable/Disable	Turns high sound level alarm detection on or off	[SENSOR ON/OFF] + [SOUND]	Enabled / Disabled	Enabled
Temperature Scale	Selects between Fahrenheit and Celsius	[SENSOR ON/OFF] + [F/C]	Fahrenheit or Celsius	Fahrenheit
Security Code	Prohibits programming changes	[SET] or [WHAT IS] + [CODE] + [4 digit code]		none
Callback Acknowledgment	Turns Callback Acknowledgment on or off	[SENSOR ON/OFF] + [PHONE]	Enabled / Disabled	Disabled

Appendix D: Accessories

The sensors listed below are available from Phonetics, Inc., and represent the most commonly used zone devices. Other dry contact sensors, designed for more specialized applications, may also be used. Commercial or industrial electrical supply houses can provide devices to monitor virtually any condition. For further information, contact Sensaphone Customer Service at 610-558-2700.

PART # SENSOR / SWITCH

FGD-0006	Magnetic Reed Switch
FGD-0007	Passive Infra-Red Detector
FGD-0010	50' two-conductor #22AWG shielded Cable
FGD-0013	Spot Water Detector
FGD-0022	Temp° Alert
FGD-0023	ISOTEL Surge Protector
FGD-0027	Humidistat
FGD-0049	Smoke Detector with Built-in Relay
FGD-0054	Power-Out Alert™
FGD-0056	Zone Water Detector w/Water Rope
FGD-0063	Additional 10' Water Rope for FGD-0056
FGD-0064	Programmable Thermostat with Remote Setback
XFR-0024	12VDC Power Supply for Thermostat
FGD-0100	Remote Temperature Sensor
FGD-0101	Weatherproof Temperature Probe
FGD-0205	Multi-Point Wireless I/O System

Appendix E: Specifications

Alert Zones

Number of Zones: 4 (thermistor installed on zone #1 for local temperature monitoring)

Zone Connector: terminal block

Zone Types: N.O./N.C. contact, 2.8K thermistor (-20° F to 150° F or -30° C to 65° C)

Zone Characteristics: 5.11K to 2.85V (Short circuit current: 1mA max.)

A/D Converter Resolution: 10 bits ± 2 LSB

Zone Protection: 5.5VDC Metal Oxide Varistor with fast acting diode clamps.

Microphone

Internal Electret Condenser: For listening in to on-site sounds and detecting high sound levels.

Phone Interface

Line RJ11 Jack: For connection to a two-wire analog telephone line. (6' modular cord included)

Extension RJ11 Jack w/ Line Seizure: For connecting other devices on the same telephone line, devices connected to this jack are disconnected in the event that the 400 must dial out for an alarm.

Phone Line Protection: Metal Oxide Varistor & self-resetting fuse

LED Indicator

System On: On steady when the unit is in RUN mode. LED blinks once every few seconds while in STANDBY mode.

Phone In Use: On steady when the telephone line is being used. LED blinks when no dial tone is detected. Off when telephone line is not in use.

Alarm: Off when no alarm exists. Blinks when an unacknowledged alarm exists. On steady when an acknowledged alarm exists

Battery Ok: On steady when the battery is in good condition. Blinks when the battery is low. Off when the battery must be replaced.

Relay Output

Rated for 1A 30VAC/1A 30VDC maximum.

Power Supply

Power Supply: 120VAC/9VDC 60Hz 6W wall plug-in transformer w/6' cord.

Power Consumption: 1.5 Watts

Power Protection: Metal Oxide Varistor

Battery Backup: Six size-C alkaline batteries (not included), providing up to 24 hours of back-up time.

Environmental

Operating Temperature: 32–122° F (0–50° C)

Operating Humidity: 0–90% RH non-condensing

Storage Temperature: 32°–140° F (0–60° C)

Physical

Dimensions: 2.1”h x 7.8”w x 8.8”d

Weight: 2 lbs.

Enclosure: Indoor-rated plastic housing suitable for wall or desktop installation.

Alarm: Off when no alarm exists. Blinks when an unacknowledged alarm exists. On steady when an acknowledged alarm exists

Battery Ok: On steady when the battery is in good condition. Blinks when the battery is low. Off when the battery must be replaced.

Appendix F: Returning the Unit for Repair

In the event that the Model 400 does not function properly, we suggest that you do the following:

- 1) Record your observations regarding the Model 400's malfunction.
- 2) Call the Technical Service Department at 815-436-4440 prior to sending the unit to us for repair.

If the unit must be sent to us for Servicing, please do the following:

- 1) Unplug the AC power supply from the wall outlet, remove the batteries, and disconnect all sensors from the alert zones.
- 2) Carefully pack the unit to avoid damage in transit. Use the original container (if available) or a sturdy shipping box.
- 3) **You must include the following information to avoid shipping delays:**
 - a) **Your name, address and telephone number.**
 - b) **A note explaining the problem.**
- 4) Contact Spectrum Technologies for a RMA number at 815-436-4440
- 5) Ship prepaid and insured via UPS or US Mail to ensure a traceable shipment with recourse for damage or replacement.

