

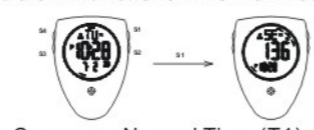

Nomad V2 Digital Compass

English

(A) FEATURES
The V2 is a digital compass that also provides temperature, dual time, chronograph, timer and alarm functions. The main features are listed as follow:



- 7 modes of operation: Compass, Normal Time (T1), Dual Time (T2), Temperature, Chronograph, Timer and Alarm.
- Electronic compass with digital direction indication in 8 positions together with degree.
- Temperature of 0.1 degree resolution and with working range from -4°F (-20°C) to 131°F (55°C).
- Temperature displayed in °F or °C selectable
- Time presents hours, minutes, seconds, month, day and weekday.
- 12/24-hour display formats selectable.
- Auto calendar from 2000-2029.
- 1/100-second chronograph with working range up to 24 hours and "Split" time.
- 1-second resolution Timer with range of 23 hours 59 minutes 59 seconds. User option for Count Down Stop, Count Down Repeat and Count Down Up function.
- 2 schedule alarms that can be set to refer to T1 or T2 and can also be set to use as daily alarms.
- Hourly chime signal, chime "on" with button confirmation sound.

- 3 second back light.

(B) BACK LIGHT
Press S4 for 3 second back light

(C) BASIC OPERATION OF BUTTONS



S1: - ENTER COMPASS MODE
- SHOW DIRECTION

S2: - VIEW NORMAL TIME OR DUAL TIME
- TOGGLE NORMAL TIME OR DUAL TIME (PRESS AND HOLD)
- VIEW TEMPERATURE IN °F OR °C
- TOGGLE TEMPERATURE IN °F OR °C (PRESS AND HOLD)
- START/SPLIT OF CHRONOGRAPH
- TIMER START
- SELECT A1/A2 OR AL
- TOGGLE ALARM AND CHIME ON OR OFF (PRESS AND HOLD)
- ADJUST SETTING (SET)

S3: - MODE CHANGE
- EXIT COMPASS MODE
- DIRECT CHANGE TO TIME MODE (PRESS AND HOLD)

- SELECT SETTING (SET)
S4: - BACK LIGHT
- START CALIBRATION (PRESS AND HOLD IN COMPASS MODE)
- SET (PRESS AND HOLD)
- STOP/RESET OF CHRONOGRAPH
- TIMER STOP
- RELOAD PRESET TIMER TIME
- EXIT (SET)

(D) MODE CHANGE OPERATION
The mode change sequence is shown as follow:

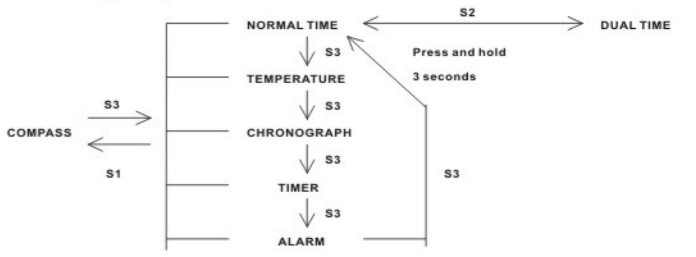

-At any mode, press and hold S3 for 3 seconds will change to time mode directly

(E) HOW TO CALIBRATE AND USE COMPASS

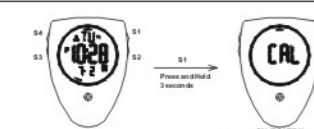

- Calibrate the compass before using for navigation.

- At any mode, press S1 to enter Compass mode.

- Direction is shown at the top 2 rows and time is shown at the lower row of the LCD.

- Select a place away from any magnetic or electronic devices (preferably open areas), press and hold S4 for 3 seconds, and the compass will be ready for calibration with "CAL" displayed.

- Holding the compass level or on top of a non-metallic table or desk, rotate the compass slowly for 2 complete rotations (each must last for at least 15 seconds), then press S4 to end the calibration and enter declination angle setting. To find the correct declination angle for your region, check the following website: <http://www.ngdc.noaa.gov/seg/geomag/jsp/Declination.jsp>

- With each press of S2, the selected digit or E/W (East/West) direction can be changed. Press and hold S2 for faster setting.

- With each press of S3, either the next digit or E/W will flash, indicating that the selected value can be changed.

- When setting E/W, press S2 to toggle East or West.

- After all adjustments are completed press S4 to end setting and return back to Compass mode.

- Holding the compass level, press S1 and the direction, in degrees and cardinal points that the compass is facing at that moment will be displayed on the screen. The indicator at the perimeter of the display will face North when S1 is pressed.

- If you press and hold S1 for 3 seconds, the direction, in degrees and cardinal points, will be detected continuously for 5 seconds.

- To exit Compass mode, press S3 to return back to the previous mode.

Caution:
The compass is very sensitive to magnetic or electric fields, so you must avoid using or calibrating the compass near any magnetic or electronic devices, as these devices may affect accuracy.

NOTE:
1. The compass displays digital direction indication in 8 positions along with degree reading.
2. Calibration allows user to align the compasses magnetic sensor with the earth's magnetic field so that the compass can detect correct direction. This should be done away from metallic objects or electro-magnetic interference.
3. Always keeps the compass level when using or calibrating it. Otherwise it may result in an erroneous reading.
4. While calibrating the compass, if it is rotated less than 2 rotations or the time for each rotation is less than 15 seconds, the directional reading may not be as accurate as it could be.
5. With the proper declination angle added, the compass will display true North as opposed to magnetic North.
6. If "Er" is displayed, the compass needs to be calibrated again.
7. If there is no button operation for about 70 seconds in Compass mode, the Nomad V2 will return back to the previous mode automatically.
8. If 24-hour display format is selected for time mode, there will be no PM "P" indicator in Compass mode.

(F) HOW TO SET TIME (T1 and T2)

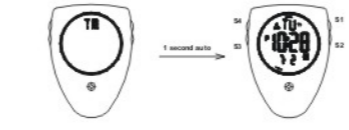

- Press S3 to show Normal Time mode (T1) or Dual Time mode (T2), mode prompt "TM" will be displayed for 1 second first.

- Weekday and T1/T2 are shown at the upper row, hours and minutes of time are shown at the middle row date and seconds of time are shown at the lower row of the LCD.

- Press and hold S2 for 3 seconds to toggle between Normal Time mode (T1) or Dual Time mode (T2).

- Press and hold S4 for 3 seconds to enter setting mode. The second digits start flashing.

- With each press of S2, the selected digits, weekday or 12/24Hr to be adjusted (flashing) can be made. Press and hold S2 for fast setting.

- With each press of S3, the next digits, weekday or 12/24Hr for setting can be selected.

- When setting seconds, pressing S2 while the second digits count between 30 to 59 will reset the second digits to 00 and 1 will be added to the minute digits.

- Year can be set from 2000 to 2029.

- When setting 12/24Hr, press S2 to toggle 12-hour or 24-hour display formats. If

24-hour display format is selected, there will be no PM "P" indicator.

- After all adjustments are completed, press S4 to exit the setting mode.

NOTE:
1. When Normal Time mode (T1) is displayed, pressing and holding S2 for less than 2 seconds allows you to view dual time without changing the mode. Use the same procedure to view T1 when using Dual Time mode (T2).
2. If there is no button operation for 2-3 minutes in setting mode, the Nomad V2 will automatically return back to T1 mode or T2 mode respectively.

(G) HOW TO USE TEMPERATURE MODE

- When in the Time Mode, pressing S3 for several seconds will display the Temperature Mode. Mode prompt "TE" will be displayed for 1 second first.

- Weekday and T1/T2 are shown at the upper row, hours and minutes of time are shown at the middle row while temperature and seconds of time are shown at the lower row of the LCD.

- Press and hold S2 for 3 seconds to toggle °F or °C display.

- The temperature displayed can be offset, to a maximum of ± 5 degrees, from the detected temperature. Press and hold S4 for 3 seconds to start temperature offset process.

- Press S2 to change the value of the flashing digit (hold down S2 for faster scrolling). Press S3 to toggle between the tenths and whole degree digits.

- After all adjustments are completed, press S4 to end the offset process.

NOTE:
The working range of temperature sensor is -4°F (-20°C) to 131°F (55°C). Beyond those limits the display shows " - - ".

2. The Nomad V2 will exit Temperature mode and change to time mode automatically after about 4 hours.

(H) HOW TO USE CHRONOGRAPH

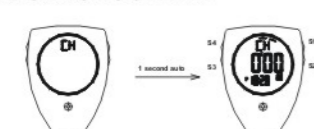

- Press S3 to show Chronograph mode, mode prompt "CH" will be displayed for 1 second first.

- "CH" is shown at the upper row, minutes and seconds of chronograph are shown at the middle row while time and 1/100-seconds of chronograph are shown at the lower row of the LCD.

- Press S2 to start the chronograph; an indicator at the perimeter of the LCD will start rotating clockwise.

- For the first 30 minutes, the chronograph shows minutes and seconds in the middle row and 1/100-seconds in the lower row of the LCD, then the chronograph shows hours and minutes in the middle row and seconds in the lower row of the LCD.

- Press S2 to take split time; "split" time will be shown for about 10 seconds (with "SPL" flashing), then the display will show current running time of chronograph.

- Press S2 again to take the next split time.

- Press S4 to stop the chronograph; the indicator at the perimeter of the LCD will stop rotating. Then press S2 to re-start the chronograph, or press S4 again to reset the chronograph back to zeros.

NOTE:
The chronograph has 1/100th of a second resolution for the first 30 minutes and 1 second resolution thereafter, with a maximum measured time of 24 hours.

(I) HOW TO USE THE TIMER

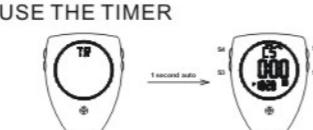

- Press S3 to show Timer mode, mode prompt "TR" will be displayed for 1 second first.

- "CS", "CR" or "CU" is shown at the upper row, hours and minutes of timer time are shown at the middle row while time and seconds of timer time are shown at the lower row of the LCD.

- Press and hold S4 for 3 seconds to enter setting mode. The seconds digits start flashing.

- Press S2 to change the value of the flashing digits (hold down S2 for faster scrolling).

- Press S3 to select the next function to be set. The sequence is shown as follows:
- Press S2 to select between Count Down Stop "CS", Count Down Repeat "CR" and Count Down Up "CU" functions.
- After all adjustments are completed, press S4 to exit the setting mode.
- Press S4 to start the timer; an indicator at the perimeter of the LCD will start rotating counter-clockwise when the timer is counting down.
- Press S4 to stop the timer. Then press S2 to re-start the timer or press S4 again to reload the preset timer time.

NOTE:
1. The timer has a 1-second resolution and a working range of up to 24 hours.
2. There are 3 different timer functions: Count Down Stop CS, Count Down Repeat "CR" or Count Down Up "CU" can be selected.
3. For Count Down Up "CU" functions, the timer can count up to 24 hours and then stop automatically.
4. If preset timer time is less than 30 seconds, the watch will beep for 1 second when the timer counts down to zero. If preset timer time is equal to or more than 30 seconds, the watch will beep for about 10 seconds When timer counts down to zero. Press any button can stop the "Beep" sound.

(J) HOW TO USE THE ALARM AND CHIME



- Press S3 to show Alarm mode, mode prompt "AL" will be displayed for 1 second first.

- Press S2 to select "A1" (alarm 1), "A2" (alarm 2) or "AL" (chime).

- "A1" / "A2" and T1/T2 are shown at the upper row, alarm time is shown at the middle row while date and status of alarm are shown at the lower row of the LCD for alarm time display.

- "AL" and T1/T2 are shown at the upper row, ":00" is shown at the middle row while time and chime status are shown at the lower row of the LCD for chime display.

- At alarm time display, press and hold S4 for 3 seconds to enter setting mode. The hour digits start flashing.

- Press S2 to change the setting of whatever digits are flashing. Press and hold S2 for fast scrolling.

- With each press of S3, the next field will begin flashing, indicating that it can now be set.

The sequence is shown as follows:

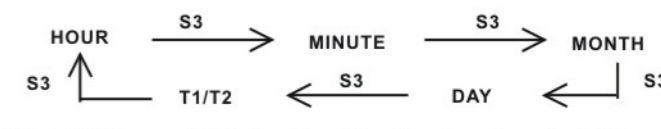

-When setting T1/T2, press S2 to toggle setting the alarm to refer to Normal Time mode (T1) or Dual Time mode (T2).

- After all adjustments are completed, press S4 to exit the setting mode.

- Press and hold S2 for 3 seconds to toggle the alarm and chime function on or off. If the alarm or chime Function is "on", the corresponding icon will be shown.



NOTE:
1. There are 2 schedule alarms that work independently and they present alarm number, T1/T2, hours, minutes, month, day and status. And they can be set to use as daily alarms if month and day are set to " - - ".
2. The alarm sounds for 20 seconds at alarm time if the alarm function is "on". Press any button to stop the alarm sound.
3. If the chime function is "on", the watch will give out "Beep" sound at every full hour and there will be button confirmation sound.
4. The alarm function is automatically set to "on" when entering setting mode.
5. The alarm icon is displayed at the time mode (T1 or T2) that the alarm is set to refer to.



Remark:
After reset, press S1 to start the compass calibration process.

(L) BATTERY REPLACEMENT
Replace with a CR2032 cell or equivalent.

(M) WARRANTY
ONE-YEAR LIMITED WARRANTY

We warrant this product against defects or malfunctions in materials and workmanship, and against failure to conform to this product's written specifications, for one year from the date of original purchase by you. WE MAKE NO OTHER EXPRESS WARRANTY OR REPRESENTATION OF ANY KIND WHATSOEVER CONCERNING THIS PRODUCT. Your remedies under this warranty will be available so long as you can show in a reasonable manner that any defect or malfunction in materials or workmanship, or any non-conformity with the product's written specifications, occurred within two years from the date of your original purchase, which must be substantiated by a dated sales receipt or sales slip. Any such defect, malfunction, or non-conformity which occurs within one year from your original purchase date will either be repaired without

charge or be replaced with a new product identical or reasonably equivalent to this product, at our option, within a reasonable time after our receipt of the product. THIS REPAIR, OR REPLACEMENT OR REFUND (AS JUST DESCRIBED) IS THE EXCLUSIVE REMEDY AVAILABLE TO YOU AGAINST US FOR ANY DEFECT, MALFUNCTION, OR NON-CONFORMITY CONCERNING THE PRODUCT OR FOR ANY LOSS OR DAMAGE RESULTING FROM ANY OTHER CAUSE WHATSOEVER. WE WILL NOT UNDER ANY CIRCUMSTANCES BE LIABLE TO ANYONE FOR ANY SPECIAL, CONSEQUENTIAL, INCIDENTAL, OR OTHER INDIRECT DAMAGE OF ANY KIND.

This warranty does NOT apply in the following circumstances: (1) when the product has been serviced or repaired by anyone other than us; (2) when the product has been altered, adjusted, or handled in a manner other than according to the instructions furnished with the product; or (3) when any defect, problem, loss, or damage has resulted from any accident, misuse, negligence, or carelessness, or from any failure to provide reasonable and necessary maintenance in accordance with the instructions of the owner's manual for the product.

We reserve the right to make changes or improvements in our products from time to time without incurring the obligation to install such improvements or changes on equipment or items previously manufactured.

This warranty gives you specific legal rights and you may also have other rights which may vary from state to state.

REMINDER: You must retain the sales slip or sales receipt proving the date of your original purchase in case warranty service is ever required.

FOR WARRANTY SERVICE, CONTACT US FOR AN RA# AT:

BRUNTON
620 East Monroe Ave
Riverton, Wyoming 82501
307.856.6559
support@brunton.com

(K) HOW TO RESET THE NOMAD V2
Press all buttons simultaneously until you hear a chime sound briefly. Then release the buttons and the Nomad V2 will be reset to default values. After reset the display will be as follows:

12

13

14