

Alpha-Log



- ▶ Linux operating system for data processing and communications. Open architecture based on integrated Linux PC
- ▶ Integrated web server for real-time data via Internet browser
- ▶ Large number of analog, digital and serial inputs. Up to 200 channels managed between measured, derived and calculated quantities
- ▶ Large multi-level internal memory (8 GB). Removable external memory (up to 32 GB)
- ▶ 3G/4G modem communication, Wireless Router, Ethernet, WiFi, Satellite. Redundant dual system with automatic switch from one mode to another
- ▶ RS232, RS485, SDI-12 ports for connection with serial sensors
- ▶ Data communication protocols: Modbus RTU/TCP data, FTP (client/server), SFTP, SMTP, SAP, MQTT, http, RMAP
- ▶ Other supported protocols: SSH, NTP
- ▶ Low power consumption with energy saving modes management
- ▶ Programmable logics for messages notifications or activating external devices
- ▶ Alarms: use of SMS, Email and local digital outputs
- ▶ Advanced processing for data statistical analysis: total values, moving and current statistical values, wind elaborations
- ▶ Remote system configuration via FTP server, or via modem / router or local network (LAN) with known and static IP
- ▶ Remote firmware update
- ▶ Internal Temperature sensor and integrated atmospheric Pressure

Alpha-Log is the latest born of the LSI LASTEM's data logger family. It contains the most efficient technical solutions assimilated in more than 40 years of experience regarding LSI LASTEM data acquisition systems. Alpha-Log was created with the objective of being an autonomous acquisition system, but also integrated into more complex systems. Based on a Linux architecture, it contains the power of this kind of operating system, but also an optimized hardware with extreme low consumption. Also, the usability and data management as well as the data output part has been designed having in mind the most modern needs.



▶ *Alpha-Log is a perfect synthesis between the classic needs of meteorological monitoring and the needs of those who want to acquire environmental parameters to manage them through complex systems, integrated in IOT networks or in local systems.*

▶ **Inputs for analog and digital sensors**

Main module (DLALB0100)

- N.2 digital inputs
- N.1 0...2 V input
- N.2 pulse input or frequency (selectable)
- N.1 Pt100 input for Temperature sensor
- N.1 Integrated Absolute Pressure sensor
- N.1 Integrated internal Temperature sensor

▶ **Input extension (ALIEM module and MSB)**

To extend the input number, Alpha-Log can be integrated with:

- ALIEM module: one (via RS232) or more (on RS485 bus)
- MSB module: one or more (on RS485 bus)

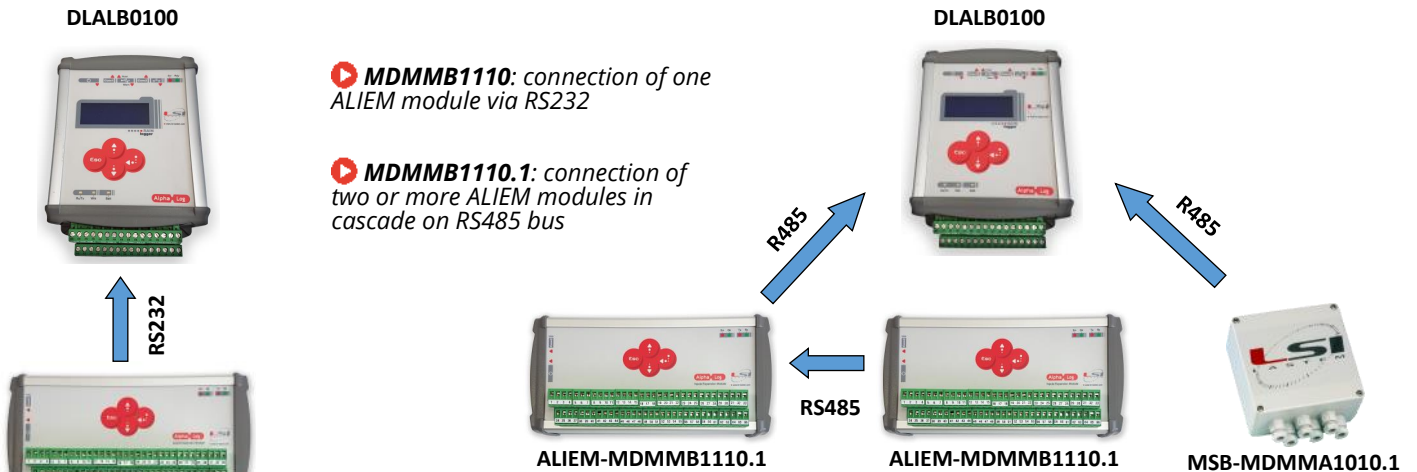

▶ **MDMMB1110:** connection of one ALIEM module via RS232

▶ **MDMMB1110.1:** connection of two or more ALIEM modules in cascade on RS485 bus

ALIEM-MDMMB1110

ALIEM-MDMMB1110.1

ALIEM-MDMMB1110.1

MSB-MDMMMA1010.1

▶ **ALIEM Inputs:**

- N. 8 differential analog (16 single-ended)
- N.4 digital (Pulse/Frequency)

▶ **MSB Inputs:**

- N.1 0...30 mV o 0...1000 mV
- N.2 Temperature Pt100
- N.1 frequency (0...10 kHz)

▶ **Inputs for Serial sensors**

Main module (DLALB0100)

- N.1 RS485 opto-insulated (N.32 Modbus sensors)
- N.1 SDI-12 opto-insulated
- N.1 UART input for DMA672.1 thermo-hygrometer

▶ **Internal web-server**

Alpha-Log has an internal web-server. Using any Internet browser, it is possible to have:

- Diagnostic information (system date/hr, IP address, battery status, events/alarms log, output status, etc)
- Instant values
- Data download from memory (ASCII, CSV, Excel, ZIP)

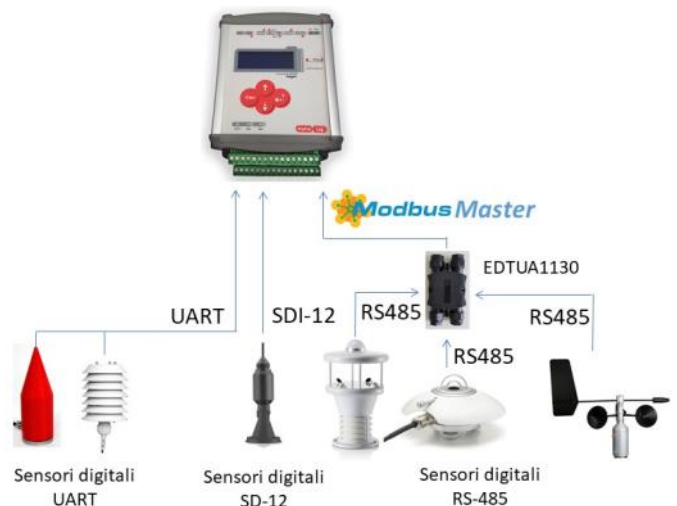

Sensori digitali UART Sensori digitali SD-12 Sensori digitali RS-485

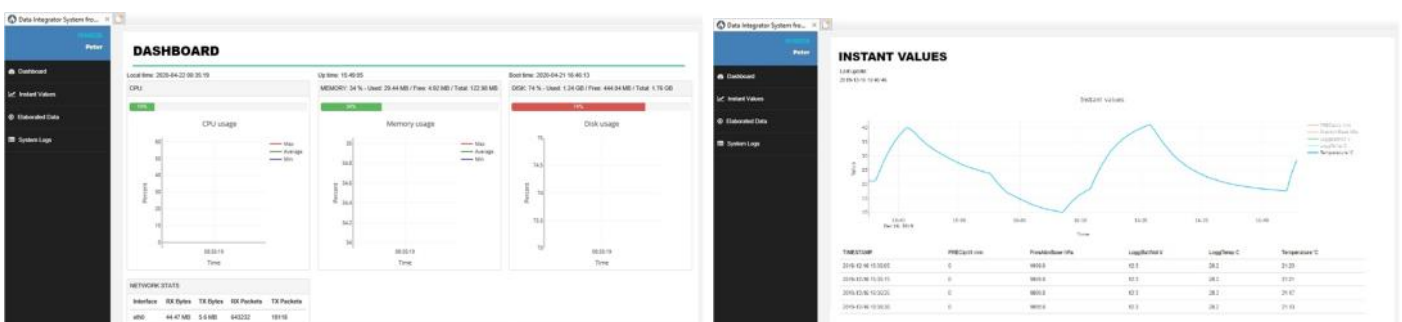

▶ Sensors acquisition rate

Acquisition rate is programmable individually for each sensor (from 1 sec to 12 hours). To limit energy consumption from sensors requiring power supply, it is possible to set an advanced power supply from the acquisition event (warm-up) that is interrupted immediately after the acquisition itself.

▶ Data elaboration

Statistical elaboration of the raw data within one or more time basis programmable individually for each channel (from 1 sec to 24 hrs):

- Average/Minimum/Maximum/Standard Deviation
- Wind elaborations
- Totals, Current Totals (useful for rain totals (*))
- Current (*) and Mobile (**) Average/Minimum/Maximum/Standard Deviation

*Currents are values in which the statistical basis corresponds to the time elapsed since the last reset up to the current time. The reset time is programmable. Example: total rainfall of the current day (from midnight to the current time).

** Mobile values are whose statistical basis corresponds to the last observation period. Example: moving average of temperature over 10 minutes (every minute the value is updated always considering the average value of the last 10 minutes).

▶ Calculated environmental quantities

The library of derived quantities lists a serie of calculations using acquired measurements, constants and other calculated quantities. The library also includes mathematical functions. Alpha-Log manages up to 200 channels between acquired, derived and calculated quantities.

(see table Calculated Quantities)

▶ Data memory

Large internal memory (8 GB total), 7 GB circular data memory, plus an extractable USB external memory (capacity up to 32 GB) with FAT32 file system. The external memory can be read directly from a PC. Alpha-Log stores data in ASCII format. The open operating system allows to develop alternative storage formats.

▶ Data communication devices

It is possible to send data to multiple independent remote servers (up to 3) by means of different devices:

- Modem 3G e 4G
- 3G-4G router
- Ethernet, Wi-Fi
- Satellite

Alpha-Log can be connected simultaneously to two communication devices and automatically choose the best option according to the availability of the signal, thus optimizing communication performance and its cost.

▶ Data communication protocols

Available data communication protocols:

- FTP (ASCII format) - data only
- SFTP (ASCII format) - data only
- SAP (Simple ASCII Protocol, property) - data only
- Modbus-RTU/TCP—data only
- MQTT (to Broker MQTT) - data and alarms
- SMTP (Email) - alarms only (data file attached)
- HTTP (read *Internal web server* part)
- SMS—alarms only
- RMAP (Remote Memory Access Protocol) - data only

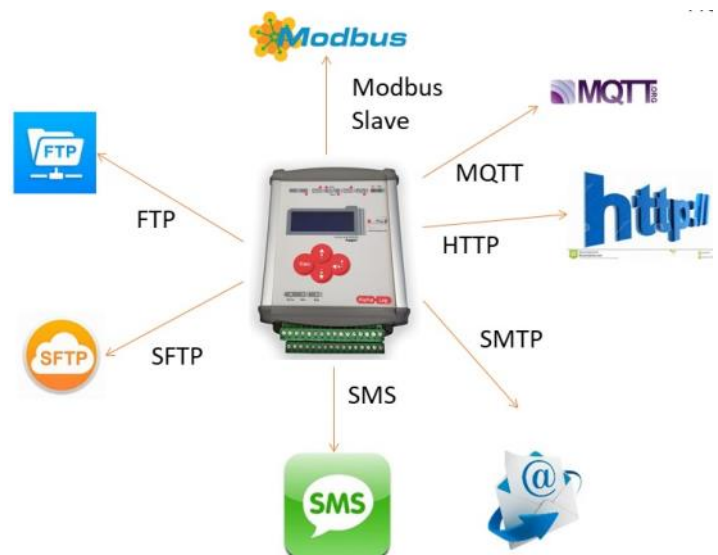

▶ Data communication protocols (Modbus protocol)

Data delivery to Modbus Master devices using:

- Modbus RTU on RS232 or RS485
- Modbus TCP on Ethernet

Transmitted data by Modbus protocol can concern instantaneous values, but also mobile statistical values*.

* Mobile values are whose statistical basis corresponds to the last observation period. Example: moving average of temperature over 10 minutes (every minute the value is updated always considering the average value of the last 10 minutes).

▶ Communication time rate

Depending on the protocol and the communication device used, it is possible to choose the shortest data communication time base to the remote server.

It is possible to set different data communication rate according to alarm statuses. For example: increase the communication rate when the rain intensity is greater than a certain programmable threshold.

▶ ASCII file data format

Alpha-Log sends data in ASCII (*.txt) format to one or more FTP servers. The content of each column inside the file is configurable.

1st column: yyyy/mm/dd

2nd column: hh:mm:ss

After the 2nd column it is possible to add following programmable information:

- Metadata: fix values in numeric format
- Data Elaborations (read *Data Elaboration*)

The sequence of the columns after the second one is programmable.

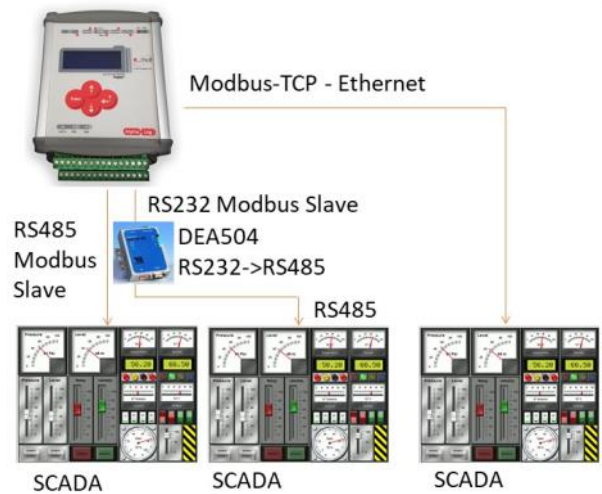

▶ Switched power supply outputs

- Alpha-Log: N.3 independent electrical outputs
- Input Extension Module (ALIEM): N.7 independent electrical outputs

Outputs are used to power sensors and external devices activated with configurable logics depending on the sensor requirement or event occurrences.

These outputs become relay outputs using an external module (MG3023).

▶ Warnings by SMS, E-mail and MQTT

Notifications/alerts delivery:

- E-mail: with editable text, scheduling and distribution lists. E-mail attachment contains the file with the data that generated the event.
- SMS: with editable text, scheduling and distribution lists up to 5 users. Active only when the device is working in low-power mode and connected through 3-4 G radio modem.
- MQTT: Alpha-Log can be programmed to send data (instant values, elaborations and alarm notifications) to a MQTT Broker server, through which are sent to programmed users.

▶ Built-in Absolute Pressure sensor

Alpha-Log is equipped with an internal Absolute pressure sensor, 500...1100 hPa range, ±1 hPa (-20...85°C) accuracy.

▶ Peripherals

Alpha-Log is equipped with the following peripherals:

- N.1 RS232-DCE port
(EMI, IEC, ESD, EFT protection filters)
- N.1 RS232-DTE port
(EMI, IEC, ESD, EFT protection filters)
- N.1 RS485 opto-insulated port
- N.2 USB Host ports, Type-A connector
- N.1 Ethernet port (RJ45)
- N.1 SDI-12 port (available within year 2022)

▶ Configuration

Alpha-Log's configuration is carried out by means of the 3DOM program on PC. The configuration file is sent to Alpha-Log through:

- Direct sending via cable or Ethernet/Wi-Fi
- Sending to the FTP server. Alpha-Log is programmed to import the configuration file directly from this FTP server
- Via the USB port of the instrument

▶ Local display and status LEDs

Alpha-Log is equipped with a back-lit LCD display (4x20 chrs). The following information are shown:

- Real-time measurements list
- Last 20 alarms list
- Statistics on communication
- System actual&start date/time
- Operative mode
- Battery status
- IP address
- Servers list
- Internal/external memory status
- Electrical output status
- Etc

On the front panel there are 3 LEDs providing diagnostics relating to the operational status of the instrument.

▶ Internal FTP area

Alpha-Log is equipped with an internal FTP area (FTP server) in which it is possible to upload external files in addition to those acquired by the connected sensors (example: images from a camera connected via Ethernet, data files from external system); these files can be sent to the remote FTP server with the same communication methods used for the transmission of the data obtained from the connected sensors. From the same FTP area, it is also possible to read, via an FTP client (example FileZilla), the data produced by Alpha-Log and stored in the area of its file system dedicated to the recording of historical data.

▶ Camera

Alpha-Log can manage an external independent IP camera using on/off programmable logics in order to to increase/decrease the number of images according to the programmed events reducing the system's power consumption and communication costs. The IP camera can be connected to the same Router used by Alpha-Log for data communication.

▶ Clock synchronization

The internal clock is updated in two ways:

- Via 3DOM program, if Alpha-Log is connected to the PC via cable or Ethernet/Wi-Fi network
- Via NTP (Network Time Protocol) whenever Alpha-Log activates an Internet connection. The time zone is defined by the configuration.



▶ Power supply

Alpha-Log runs at 9...30 Vdc. The internal regulator allows to charge an external Pb battery, through solar panel or main power supply.

▶ Power consumption and battery duration

Alpha-Log average electrical consumption is 0.03 W during stand-by and measurements; 2.4 W with active communication. Power consumption of the input extension module (ALIEM) is 0.12 W being always active. The consumptions do not include the communication device. Battery duration is listed in the following tables.

Comm.rate	Consumption Alpha-Log (average)	Consumpt. Alpha-Log + ALIEM(average)
1 com/day	60 mW	180 mW
1 com/hr	600 mW	720 mW

Power consumption. Using 3G modem and sensors without own power consumption, display off.

Comm.rate	Battery power Battery autonomy (days)		
	9 Ah	15 Ah	40 Ah
1 com/day	65	110	300
1 com/hr	6	11	30

Power autonomy in days. Alpha-Log only. Including 3G modem. Using sensors without own power consumption. Starting from fully charged battery and without sun.

Comm.rate	Battery power Battery autonomy (days)		
	9 Ah	15 Ah	40 Ah
1 com/day	20	35	100
1 com/hr	5	8	25

Power autonomy in days. Alpha-Log and ALIEM. Including 3G modem, sensors without own power consumption, starting from fully charged battery and without sun.

▶ Data management

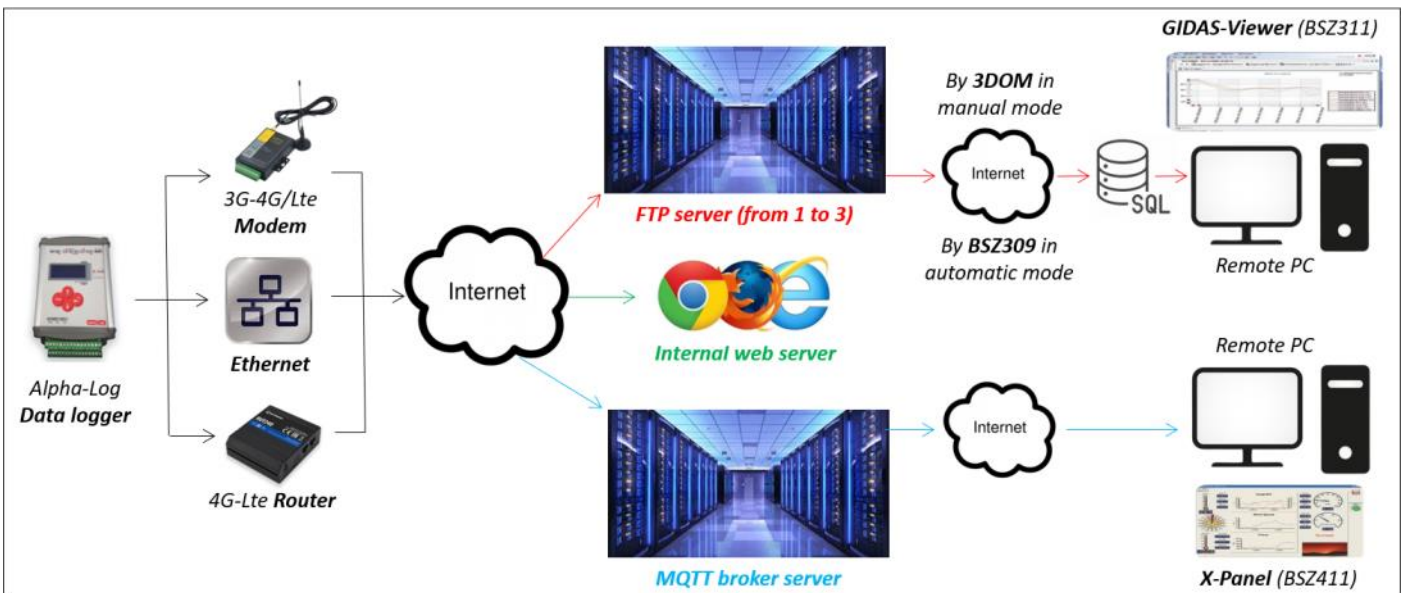

The **Alpha-Log data logger** can **transmit data** to the FTP cloud server or the MQTT broker server via: 3G-4G / Lte modem, Ethernet, 4G-Lte router.

Once stored on the FTP server, the data is downloaded to a remote computer through two download methods:

1. **Manual mode:** thanks to the **3DOM** software it is possible to manually download the data
2. **Automatic mode:** through the **P1CommNET** soft-

ware (BSZ309) it is possible to perform automatic data download. In order to always get the latest data available on the server, the remote PC must remain switched on

The data are stored on the remote PC in a SQL-GIDAS database to be managed by LSI LASTEM programs that use this database, such as the **GIDAS-Viewer** program (BSZ311) for data processing and reporting. The GIDAS-Viewer software can be installed on several PCs on the same network.

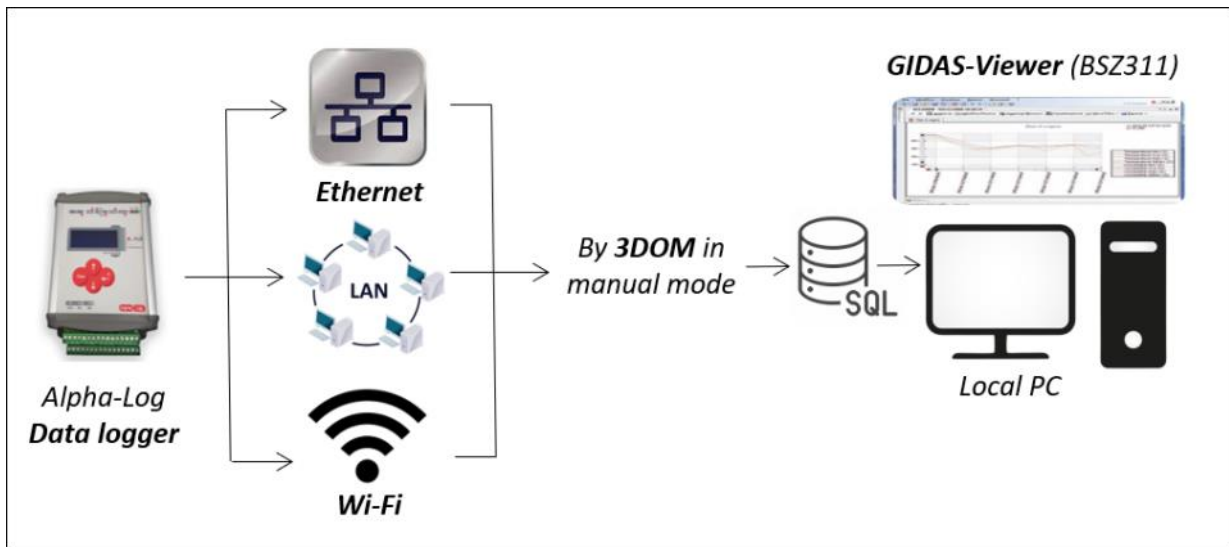

▶ **Connection to a local PC**

Alpha-Log can be directly connected to a local PC or LAN network through SSH protocol via Ethernet or Wi-Fi. Data are downloaded through 3DOM software and are locally saved on SQL database to be managed through LSI LASTEM softwares that manage this database.

▶ **Installation**

Alpha-Log can be placed inside IP66 enclosure ELF series against shock, water, dust and atmospheric agents. Depending on the ELF's model, the enclosure can also accommodate power systems, communication devices and batteries.



▶ **A-Log with ALIEM module** inside a ELF340 box with the following included accessories:

- Converter 110-230 Vca-> 13,8 Vcc
- Magnetomic switch
- 2Ah Back-up battery



▶ IP66 for portable or fix applications

Alpha-Log models

Code	DLALB0100
	
Description	Alpha-Log data logger
Inputs type	Terminal block
Analog inputs	N.1 0...2 Vdc input
Digital inputs	N.2 pulse inputs
RS232 ports	N.2
USB ports	N.2
RS485 port	N.1
SDI-12 port	N.1
Integrated Absolute Pressure sensor	YES
Integrated Temperature sensor	YES
On/off outputs	YES
Backlit display	YES
Internal battery	NO
Included accessories	Ethernet cable, DIN-bar mounting

Alpha-Log (DLALB0100)—Technical Features

Inputs ALIEM module (MDMMB1110,	<i>See MW9008-ENG-05-ALIEM data sheet</i>	
Pulse input / frequency (selectable)	Inputs number	N.2
	Features	<ul style="list-style-type: none"> • N.2 single relay reeds from two rain gauges • One rain gauge with double reed relay system • N.2 frequency inputs from two optoelectronic anemometers • N.1 relay reed from one rain gauge and N:1 frequency input from optoelectronic anemometer
	Power supply	Limited to 1 mA per reed relay
	Input type	Open collector with 3,3 V pullup resistance (positive input)
	Max input frequency	480 KHz (reed relay input) 10 KHz (frequency input)
	Rainfall linearization	Yes (using correction formula for Class A rain gauges according to UNI EN 17277:2020)

	Protection	<ul style="list-style-type: none"> • From reed relay rebounds • From over-tension (> 5V) • 400 W peak pulse power capability at 10/1000 μs waveform. Repetition rate (duty cycle): 0,01 % • IEC-61000-4-2 ESD 30 kV (air), 30 kV (contact) • ESD protection of data lines in accordance with IEC 61000-4-2 • EFT protection of data lines in accordance with IEC 61000-4-4
Input (Temperature RH%)	Input	UART-TTL (DMA672.1 sensor), (DMA672.4 sensor when ELUxxx box is used)
	Range	<ul style="list-style-type: none"> • Temperature: -40...70°C • RH%: 0...100% • DewPoint: -40...70°C
	Resolution	<ul style="list-style-type: none"> • Temperature: 0,1°C • RH%: 0...100% • Dew Point: 0,1°C
Input Pt100 (Temperature sensor)	Input	Pt100 (3 wires)
	Range	-40...70°C
	Resolution	0.1°C
	Accuracy	\pm 0.25 °C
Input Voltage	Range	0...2 V
	Resolution	12 bit
	Accuracy	1.8 mV
	Dropping resistors	100 ohm (N.1 included to convert 4...20 mA -> 200...1000 mV)
Internal Measurement (Absolute Pressure)	Range	500...1100 hPa
	Resolution	Typically 0.084 hPa
	Accuracy	\pm 1 hPa (-20...85°C)
	Long term stability	\pm 1 hPa/year
Internal Measurement (Power)	Mode	Battery or power supply level
	Type	Voltage
SDI-12 input	Type	V1.1 compliant
	Protections	<ul style="list-style-type: none"> • Opto-insulation • Over-current protection by self-replacing PTC fuse • IEC-61000-4-2 ESD 30 kV (air), 30 kV (contact) • DATA-SDI12 line protection with gas discharger and digital insulation: <ul style="list-style-type: none"> ◇ 1-2 kA surge capability tested with 8/20 μs pulse as defined by IEC 61000-4-5 ◇ Conform to ITU-T K12, IEC 1000-4-5 ◇ Insulated Data line up to 4000V peak and 2500V rms per minute
RS485 Input/output	Input numb.	N.1
	Mode	<ul style="list-style-type: none"> • Connection to sensor (Modbus RTU Master protocol) • Connection to SCADA/PLC systems (Modbus RTU Slave protocol)
	Power supply	3kVdc insulated

RS232 Input/output	Inputs numb.	N.2
	Mode	<ul style="list-style-type: none"> • Connection to Input Extension Module (MDMMA1110) • Connection to communication devices (modem 3G/4G) • Connection to SCADA/PLC devices (Modbus RTU - Slave protocol)
USB Input/output	Number	N.2
	Type	Host, connection type A
	Mode	<ul style="list-style-type: none"> • Connection to pen-driver • Connection to Wi-Fi antenna (optional)
Switched power supply outputs	Outputs numb.	N.3 (programmable triggering)
	Type	Solid-state V Out = V In
	Max tension	1.1 A for each output
	Mode	<ul style="list-style-type: none"> • External sensors power supply • Communication system power supply • Alarm • Timer (date/time or cycles)
	Protections	400 W peak pulse at 10/1000 μ s waveform Repetition rate (duty cycle): 0,01%
Memory	Size/Type	8 GB Flash with UBIFS file system
	Data memory	Two levels storage system for greater reliability: <ul style="list-style-type: none"> • 7 GB on Flash chip with UBIFS file system • Up to 32 GB on USB memory stick with FAT32 file system
User's interface	Display	57x19 mm. 4 lines x 20 char. Backlit
	Keyboard	N.4 buttons
	Leds	Diagnostic about: <ul style="list-style-type: none"> • Data transmission activity • System status • Battery charge status • Internal Linux computer status (ready/error)
Clock	Accuracy	1 minute/month accuracy
	Synchronization	Automatic from internet time (NTP)
ADC	Resolution	12 bit oversampled to 14 bit; 16 bit optional
	Filter	Noise filtering for 50/60 Hz
Data Transmission	Modem	External 3G/4G modem (connection to RS232 port)
	Router	3G/4G router (connection to Ethernet port)
	Wifi	External antenna connected to USB port
Linux Computer	Type	Linux based internal computer with open and end-user extensible architecture
	Processor	32 bit
	ADC converter	16 bit

	Power modes	<ul style="list-style-type: none"> Always ON (always connected to Internet) Automatic power ON (awake for data transmission only for best energy performance)
	Linux kernel	V. 2.6.35, Debian Wheezy distribution
	Ethernet	Ethernet 10/100 Mbps
	USB ports	N.2 USB ports, Host, Type-A connector
	RAM	128 MB
Watch dog	Type	Dual/redundant watch dog system
Power supply	Power supply	6...30 Vdc
	Inputs	Separate inputs from 6...30 Vdc power supply : <ul style="list-style-type: none"> From solar panel (17 Vmin), Max current: 5 A. Recharge voltage: 13,8 V From battery/main power supply, Max current: 5 A
	Peak pulse power capability	400 W peak pulse at 10/1000 μ s waveform, Repetition rate (duty cycle): 0,01%
	Battery charge	17 V
	Protections	<ul style="list-style-type: none"> IEC-61000-4-2 ESD 30 kV (air), 30 kV (contact) Over-current protection by self-replacing PTC fuse Polarity inversion protection Over current protection by input power supply (>33V) 400 W peak pulse power capability at 10/1000 μs waveform
Environmental Limits	Operating temperature	-40...80 °C (display off)
	Operating humidity	10...99 % RH, not condensing (conformal coating option)
	Storage temperature	-40...80 °C
Physical parameters	Weight	600 g
	Dimensions	160x125x50 mm
	Mounting	DIN mounting rail 35 mm
EMC	Protections	EN61326-1 2013, EMC CEI EN 61010-1 2013
RoHS	Compatibility	CEI EN 50581_01 2013

Accessories

	SVSKA2001	Data logger programming hardware kit for firmware update. Complete with connection cable, user manual and program
	XLA010	USB Memory stick, 8 GB, Industrial grade
	EDECA1001	N.5 50 ohm-resistors kit (1/8 W, 0.1%, 25 ppm) to convert 4...20 mA -> 200...1000 mV